

Riso shall not be responsible for any damage or expense that might result from the use of this manual. As we are constantly improving our products, the machine may differ in some respects from the illustrations used in this manual.

Riso shall not be liable for any direct, incidental, or consequential damages of any nature, or losses or expenses resulting from the use of this product or included manuals.



Countries of intended use

Austria/Belgium/Denmark/Finland/France/Germany/Greece/Iceland/Ireland/
Italy/Luxembourg/Netherlands/Norway/Portugal/Spain/Sweden/Switzerland/U.K.

RISO is a registered trademark of RISO KAGAKU CORPORATION in Japan and other countries.
riso iQualitySystem™ is a trademark of RISO KAGAKU CORPORATION.

- **This product contains RFID (Radio Frequency Identification) System.**
- **The information contained in this document is subject to change without notice.**

Copyright © 2003 RISO KAGAKU CORPORATION

Contents

Welcome to the RISO RZ Series Model	5
Getting Acquainted	6
Parts and Components	6
Control Panels	8
Before Starting to Use	12
Safety Guide - Installation	12
Installation	12
Power connection	13
Connection with a Computer (Option)	14
Paper Recommendations	15
Size and Weight Restrictions	15
Tips for Better Paper Feeding	16
Storing Environment	16
Originals	17
Size and Weight Restrictions	17
Maximum Printing Areas and Margins	18
Materials Not to Be Printed	18
Preparing to Print	19
Setting up the Paper Feed Tray	19
Adding or Replacing Paper	20
Setting up the Paper Receiving Tray	21
Basic Operations	24
Safety Guide - Handling and Operation	24
Operation Environment	24
Machine Handling	24
Consumables	25
Ink Handling	25
Basic Process	26
Basic Operations	27
Printing from a Paper Document or Book	27
Printing with Data Generated by a Computer (Optional Kit Required)	30

Setting up for Scanning Originals 32

Selecting the Image Processing Mode [Line, Photo, Duo] 32

Scanning Originals Written with Pencils [Pencil] (For RZ2XX, unavailable)..... 33

Processing Photos with Dot Screening [Dot Process] (For RZ2XX, unavailable) 34

Enlarging and Reducing Originals [Enlargement/Reduction] 35

 Enlarging and Reducing by Standard Ratios [Standard] 35

 Enlarging and Reducing with the Zoom Function [Zoom] (For RZ2XX, unavailable) 36

Scanning Originals Having Faint or Dark Contents [Scanning Level Adjustment] 37

Reproducing Bound Documents [Book Shadow Edit] 38

Printing Originals Side-by-Side [2-Up Printing]..... 39

 Single-Original Printing and Two-Original Printing 39

 Restrictions on 2-Up Printing 40

 Operational Procedure 41

Automatic Printing [Auto-Process]..... 43

Saving Ink [Ink Saving]..... 44

Setting up for Printing 46

Producing Proof Copies [Proof] 46

Adjusting the Print Density [Print Density Adjustment] (For RZ2XX, unavailable) 47

Adjusting the Print Position [Print Position Adjustment] 48

 Adjusting the Vertical Position 48

 Adjusting the Horizontal Position 48

Changing the Print Speed [Print Speed Adjustment]..... 50

Advanced Features 52

Automatic Sorting into Groups [Programmed Printing]..... 52

Idling Action [Idling] 55

Protecting Confidential Documents [Confidential Mode] 56

Printing with a Linked Printer (Option) (For RZ2XX, unavailable) 57

Customising the Initial Settings [Custom Setting Mode]..... 59

 Changing Procedure..... 63

 IP Address Setting (for RZ2XX, unavailable) 65

 Setting the Link-free volume (for RZ2XX, unavailable) 67

Contents

Replacing and Disposing Consumables 68

Replacing the Ink Cartridge 68
Replacing the Master Roll 70
Emptying the Master Disposal Box..... 73
Disposal of Depleted Consumables 74
Removing and Installing the Print Drum 75

Cleaning 78

Safety Guide - Cleaning 78
Cleaning 79
 Thermal Print Head 79
 Platen Glass and Platen Cover 79
 Pressure Roller 80
 Printer Exterior 80
 Scanner Glass and White Sheet of the ADF unit (Option) 81

Troubleshooting 82

Check & Error Display 82
 Checking with the Check & Error Display 82
Troubleshooting Tips 92

Appendixes 100

Optional Accessories 100
Specifications 101
Feature List..... 105
Index..... 106

Welcome to the RISO RZ Series Model

Thank you for purchasing this printing machine that produces clear prints with easy key operations. Besides many useful functions as a printer, the machine provides you with various conveniences such as Progressive Arrow indicators that show the progress of the master-making and printing processes and the Receiving Tray Paper Guide that allow you to easily pick up printed copies.

About This User's Guide

This manual contains detailed instructions concerning the operation and maintenance of the machine. In order to optimize use of the machine, all operators should carefully read and follow the instructions contained in this manual. This manual also contains a troubleshooting guide for easy reference.

About the notation in an explanatory note

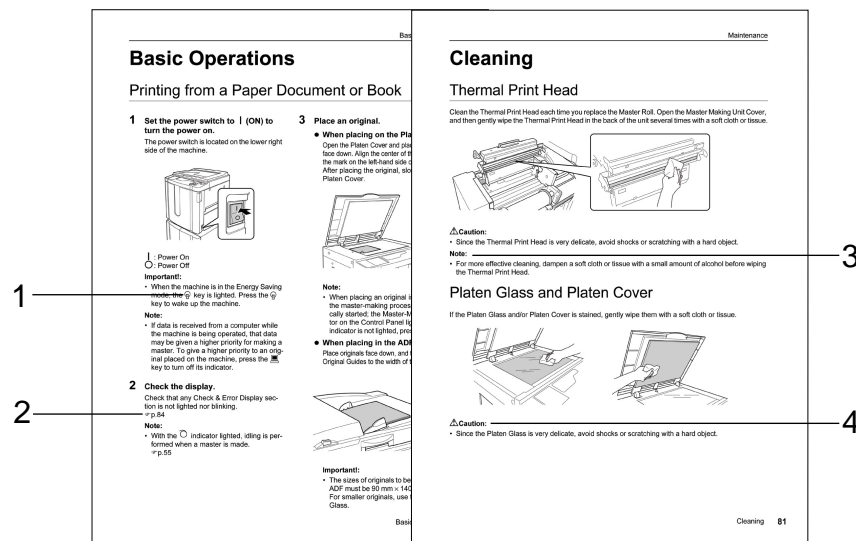

- 1) **Control panel key**
The pictogram in a sentence designates a key on the control panels.
- 2) **Cross-reference Remark** ()
Shows a reference page.
- 3) **Advice Remark**
Important!: Provides such information as those that should be paid special attention and inhibited performances.
Note: Gives you useful information.
Tip: Gives you additional hints for more convenience.

- 4) **Safety Remark**
Safety instructions are described under the following icons.



About Information and Illustrations on This Manual

Keep the following in mind about information and illustrations in this manual.

- Some functions described in this manual are supported only by the RZ3XX; those are unavailable on the RZ2XX.
- For the illustrations of the machine's outlines and control panels, those for the RZ370 have been used.

Getting Acquainted

Parts and Components

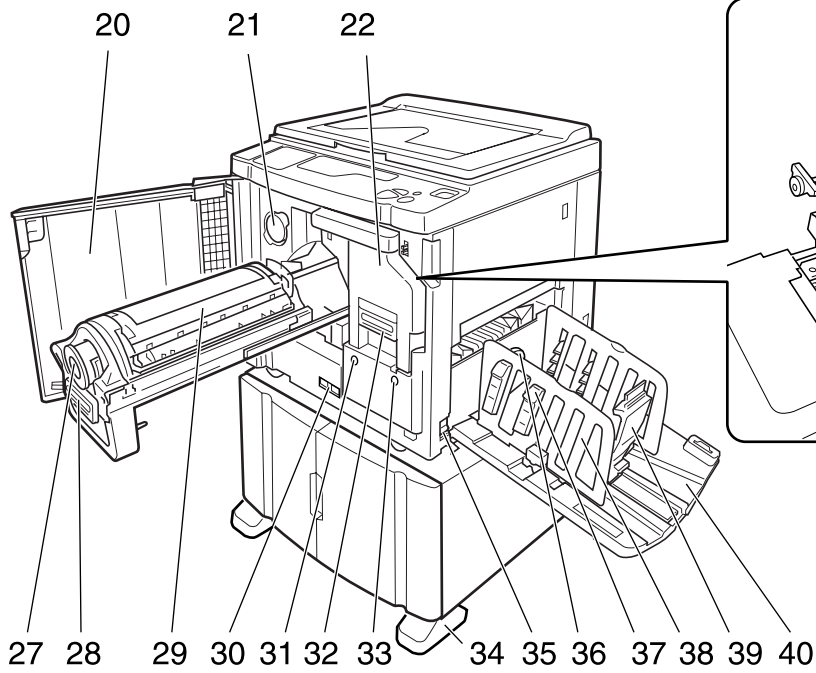
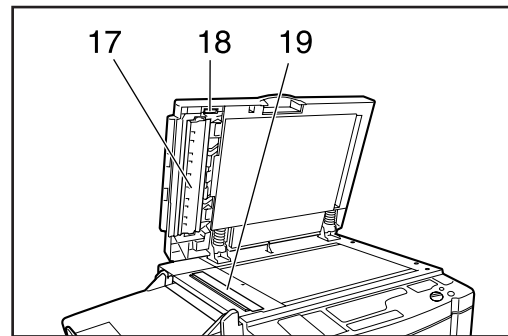
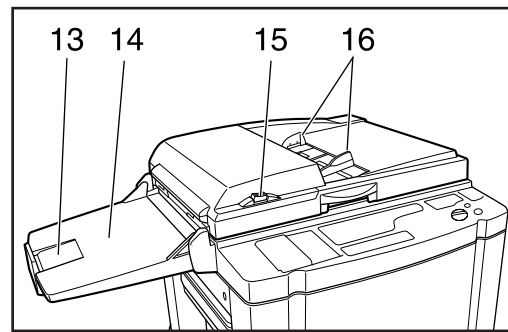
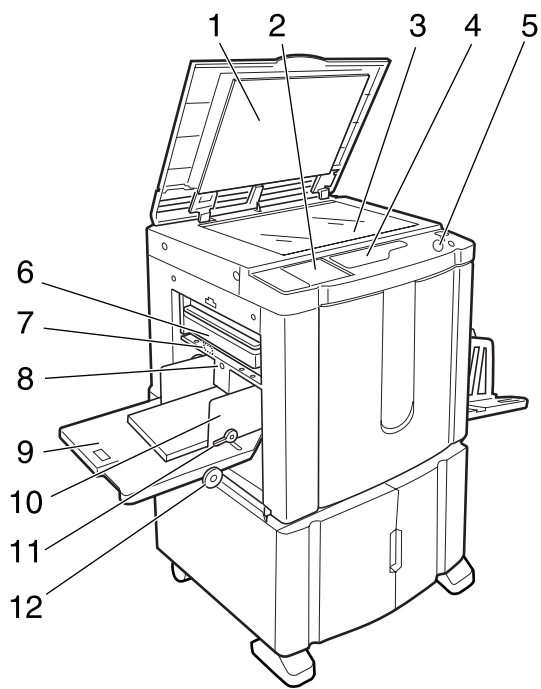

- 1) **Platen Cover**
- 2) **Sub Control Panel** (p.10)
- 3) **Platen Glass** (p.79)
Place an original face down.
- 4) **Main Display** (p.82)
- 5) **Main Control Panel** (p.8)
- 6) **Master Disposal Box** (p.73)
Holds discarded masters.
- 7) **Paper Feed Pressure Adjustment Lever** (p.19)
Adjusts the paper feed pressure according to paper in use.
- 8) **Feed Tray Descent Button** (p.20)
Lowers the Paper Feed Tray when replacing or adding paper.
- 9) **Paper Feed Tray** (p.19)
- 10) **Feed Tray Paper Guide** (p.19)
Holds and guides paper.
Slide to fit to the sides of paper.
- 11) **Feed Tray Paper Guide Lock Lever** (p.19)
Locks the Feed Tray Paper Guides.
- 12) **Horizontal Print Position Adjustment Dial** (p.48)
Move the print position to the left or right.
- 13) **ADF Original Stopper (Option)**
Stops originals scanned by the ADF unit.
- 14) **ADF Original Receiving Tray (Option)**
- 15) **ADF Original Release Button (Option)**
Press to release originals fed into the ADF unit when a paper jam occurs or originals need to be repositioned.
- 16) **ADF Original Guide (Option)**
Holds and guides originals in the ADF unit.
Slide to fit to the sides of paper.
- 17) **ADF White Sheet (Option)**
- 18) **ADF Original Release Dial (Option)**
Use to release originals fed into the ADF unit when a paper jam occurs.
- 19) **ADF Scanner Glass (For RZ3XX, option)**
- 20) **Front Cover**
- 21) **Ink Cartridge Cap Holder** (p.68)
- 22) **Master Making Unit** (p.70)
- 23) **Master Making Unit Cover** (p.70)
- 24) **Master Guide Flap** (p.70)
- 25) **Master Roll** (p.70)
- 26) **Master Roll Holder** (p.70)
- 27) **Ink Cartridge** (p.68)
- 28) **Print Drum Handle** (p.75)
- 29) **Print Drum** (p.75)
- 30) **Counter**
Counts the number of copies (total print counter) and the number of made masters (master counter).
- 31) **Print Drum Release Button** (p.75)
Unlocks the Print Drum for removal.
- 32) **Master Making Unit Handle** (p.70)
- 33) **Master Making Unit Release Button** (p.70)
Unlocks the Master Making Unit for removal.
- 34) **Stabilizer**
- 35) **Power Switch**
- 36) **Paper Ejection Wing Adjustment Dial (For RZ2XX, unavailable)** (p.21)
Adjust according to the finish and size of paper in order to align printed paper.
- 37) **Paper Arranger (For RZ2XX, unavailable)** (p.21)
Press to open for aligning printed paper.
- 38) **Receiving Tray Paper Guide** (p.21)
Aligns printed paper neatly.
Slide according to the width of paper to be printed.
- 39) **Paper Stopper** (p.21)
Stops paper printed and ejected into the Paper Receiving Tray.
Slide according to the length of paper to be printed.
- 40) **Paper Receiving Tray** (p.21)

Getting Acquainted

Control Panels

Main Control Panel

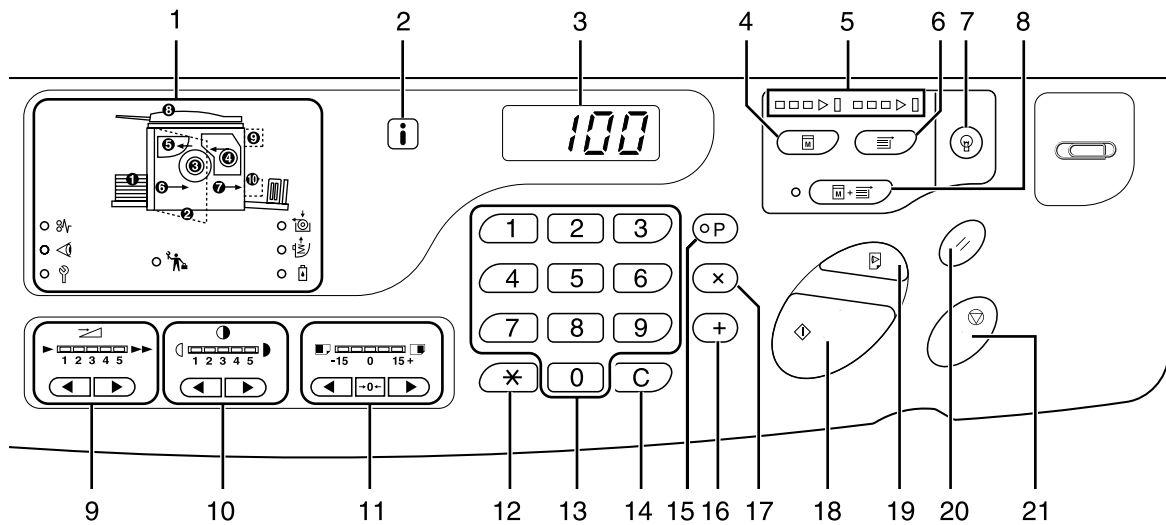

- 1) Check & Error Display (p.82)**
Indicates error locations and status.
- 2) indicator**
- 3) Print Quantity Display (Error number display)**
Shows the number of printed copies, numeric values entered for various settings, and error numbers.
- 4) Master-Making Key**
Makes the printer be ready for making masters.
- 5) Progress Arrows**
Indicates master-making and printing progress status.
When making masters is ready, all the indicators above the Master-Making Key light.
When printing is ready, all the indicators above the Print Key light.
- 6) Print Key**
Makes the printer be ready for printing.
- 7) Wake-Up Key**
Wakes up the printer in Energy Saving mode.
- 8) Auto-Process Key/Indicator (p.43)**
Perform non-stop operation from master-making through printing.
When activated, the indicator besides the key lights.
- 9) Print Speed Adjustment Keys/Indicator (p.50)**
Select the print speed from five levels.
The indicator above the keys shows the current speed level.
- 10) Print Density Adjustment Keys/Indicator (For RZ2XX, unavailable) (p.47)**
Select the print density from five levels.
The indicator above the keys shows the current density level.
- 11) Vertical Print Position Adjustment Keys/Indicator (p.48)**
Adjust the print position in the vertical direction (within ±15 mm) after making a master.
The indicator above the keys shows the offset amount from the centre.
To clear the offset amount, press →0← .
- 12) X Key**
Use when printing with an optional Linked Printer.
- 13) Print Quantity Keys (0 to 9 Keys)**
Use to enter the number of copies to be printed or to enter other numeric values.
- 14) C Key**
Cancels entered numeric values or resets the counter to zero.
- 15) P Key/Indicator (p.52)**
Allows the printer to print and group copies as specified (programmed printing).
When activated, the indicator above the key lights.

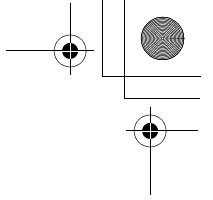
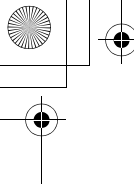

16) + Key

Use when setting up for programmed printing or when changing the initial settings.

17) × Key

Use when setting up for programmed printing.

18) Start Key

Starts master-making or printing process or executes specified operations.

The key is lighted only when the key is active.

19) Proof Key (p.46)

Use when you want to check print result after adjusting the print position, for example.

This allows you to print sample copies without affecting the value on the Print Quantity Display.

20) Reset Key

Returns all settings to the initial settings.

21) Stop key



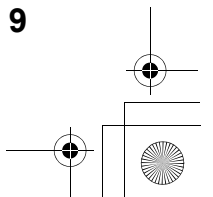
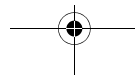
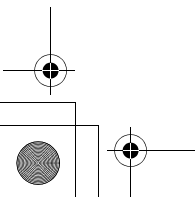
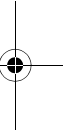
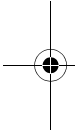



Stops operation in progress.

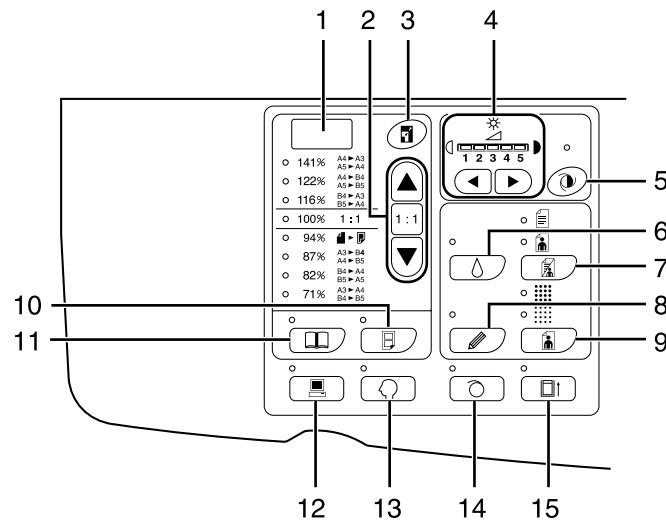

Getting Acquainted

Sub Control Panel



- 1) Free Reproduction Size Display (For RZ2XX, unavailable) (p.36)**
Shows the enlargement/reduction ratio specified using the zoom function.
- 2) Reproduction Size Selection Key (p.35)**
When selecting from among the standard reproduction sizes, press ▲ / ▼ to switch the selection. The corresponding indicator lights to indicate the current selection.
To restore 100%, press 1 : 1.
- 3) Zoom Key (For RZ2XX, unavailable) (p.36)**
Allows you to change the reproduction size in the range from 50% to 200%.
After pressing , you can change the size in increments of 1% using the selection keys. Each time you press the key, the function is switched on and off.
- 4) Scanning Level Adjustment Keys/ Indicator (p.37)**
Select from five scanning levels.
The indicator above the keys shows the current scanning level.
- 5) Auto Scanning Level Adjustment Key/ Indicator (For RZ2XX, unavailable) (p.37)**
Automatically selects the optimum scanning level for the current original.
Each time you press the key, the function is switched on and off.
When activated, the indicator above the key lights.
- 6) Ink Saving Key/Indicator (p.44)**
Makes the printer save ink.
Each time you press the key, the function is switched on and off.
When activated, the indicator above the key lights.
- 7) Image Processing Selection Key/Indicator (p.32)**
Each time you press the key, the Image Processing mode is changed.
When the Line mode is selected,  lights. When the photo mode is selected,  lights. When the Duo(text/photo) mode is selected, both  and  light.
- 8) Pencil Key/Indicator (For RZ2XX, unavailable) (p.33)**
Select for an original written using a pencil.
Each time you press the key, the function is switched on and off.
When activated, the indicator above the key lights.
- 9) Dot Screen Selection Key/Indicator (For RZ2XX, unavailable) (p.34)**
Adjusts shade in pictures when printing.
Each time you press the key, the selection is switched among  (COARSE) →  (FINE) → and no shade. The corresponding indicator lights depending on the selection.
- 10) 2-UP Key/Indicator (p.39)**
Allows side-by-side printing with a single paper.
Each time you press the key, the function is switched on and off.
When activated, the indicator above the key lights.
- 11) Book Key/Indicator (p.38)**
Use when placing a magazine or book as an original for printing.
Each time you press the key, the function is switched on and off.
When activated, the indicator above the key lights.

12) Interface Key/Indicator (p.30)

When connected with a computer (optional kit needed), switches between line connection and disconnection.
When the line is in connection, the indicator above the key lights.

13) Custom Key/Indicator (p.59)

Use when changing the initial settings.
When activated, the indicator above the key lights.

14) Idling Key/Indicator (p.55)

Sets up for idling.
Each time you press the key, the function is switched on and off.
When activated, the indicator above the key lights.

15) Confidential Key/Indicator (p.56)

Prevents confidential documents from being copied.
Each time you press the key, the function is switched on and off.
When activated, the indicator above the key lights.

Important!:

- For 1) through 11), the keys need to be operated before a master-making process is started; otherwise settings become ineffective.

Before Starting to Use

Safety Guide - Installation

This section describes the precautions to be observed when installing the machine. Read this section before installing the machine.

Note:

- Your dealer will help you to determine a proper location for the machine at the time of delivery.

Installation

▲WARNING:

- Place the machine on the dedicated stand for this model or on a flat and stable surface (maximum of 10 mm differential allowed). Injury might occur if the machine falls.
- Install the machine in a well-ventilated area. Failure to do so may result in serious health problems.

▲Caution:

- Install the machine near the wall socket to avoid using an extension cord between the machine and the wall socket. If an extension cord is absolutely required, do not use one longer than 5 m.
- Allow at least 10 cm or more of clearance behind the machine so that you can unplug the machine in case of technical difficulties.
- Keep the machine away from dusty environments. Failure to do so may result in fire.

Important!:

- Avoid installing the machine in the locations listed below. Failure to observe this precaution may lead to machine failure.
 - Locations with exposure to direct sunlight, such as locations close to windows (Curtain all windows that might expose the machine to direct sunlight)
 - Locations that are subject to sudden changes in temperature
 - Extremely hot and humid locations or cold and dry locations
 - Heated locations
 - Locations exposed to direct cold air, direct hot air, or direct radiant heat

Power connection

⚠ WARNING:

- Do not overload the wall socket or extension cord, nor damage the power cord by placing heavy objects on it or pulling or bending it. This can result in fire or electric shock.
- Do not pull the power cord but hold the plug itself when unplugging it. This can damage the cord and result in fire or electric shock.
- Do not plug or unplug the power cord if your hands are wet. This can result in electric shock.

⚠ Caution:

- Pull out the power cord plug from the wall socket more than once a year and clean the prongs of the plug and their surroundings. Dust collected on these areas can result in fire.

Important!:

- Check the power cord and plug for poor connections. Plug the power cord securely into a nearby wall socket.
- Be sure to turn off the POWER switch when connecting or disconnecting a cable.

Before Starting to Use

Connection with a Computer (Option)

With an optional interface board (Printer Control Board RISORINC3N) installed, you can directly send data from a connected computer to the machine as an original for printing. Because digital data itself is used for making a master, the finish of prints becomes outstanding.

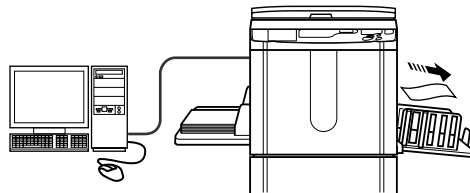

Important!:

- Before making the connections, turn off both the machine and computer.
- The maximum allowable voltage for parallel connector input and output is 5 V.

Connection Method	Option Needed	Cable	
one-to-one connection with a Windows PC	Printer Control Board RISORINC3N	Parallel printer cable	IEEE1284 conformed
One-to-one connection with a Macintosh (Windows PC also acceptable)	Printer Control Board RISORINC3N RISORINC-NET	Ethernet cable (cross)	Shielded cable that supports 10BASE-T or 100BASE-TX
Network connections	Printer Control Board RISORINC3N RISORINC-NET	Ethernet cable (straight)	

Paper Recommendations

Size and Weight Restrictions

The table shows the specifications of the usable print paper.

Model	Usable Printing Paper	
	Size	Weight
RZ370/RZ300	100 mm × 148 mm to 297 mm × 432 mm	46g/m ² to 210g/m ²
RZ230/RZ200		46g/m ² to 157g/m ²

Important!:

- Even when using paper whose sizes and weight are supported by the machine, it may not pass through the machine depending on such factors as paper finish, ambient conditions, and storage conditions. Keep this in mind when using the machine. For more information, consult your dealer.

Do not use the following types of paper, as they can cause jams or misfeeds:

- Extremely thin paper (less than 46 g/m²)
- Extremely thick or heavy paper (greater than 210 g/m² for RZ3 series or greater than 157 g/m² for RZ2 series)
- Wrinkled, curled, folded, or torn paper
- Chemically treated or coated paper (such as thermal or carbon paper)
- Paper having a sticky section or holes (such as an envelope and label paper)

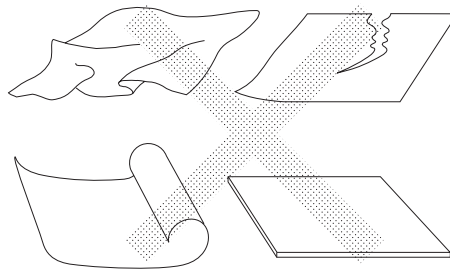

Note:

- Paper with a horizontal grain direction can cause problems with paper supply. Use paper with a vertical grain direction.
- Images are not output onto the entire area of usable print paper. The maximum printing areas differ among models. [p.18](#)

RISO does not assure that paper outside the above specifications pass through the machine and can be used for printing.

Before Starting to Use

Tips for Better Paper Feeding

To prevent paper jams and misfeeds, follow the directions below:

- When using standard or light-weight paper, set the Paper Feed Pressure Adjustment Lever to “✕”. Then set the Paper Ejection Wing Adjustment Dial (for RZ2XX, unavailable) according to the paper size and open all four Paper Arrangers (for RZ2XX, unavailable). For RZ2XX, set the corrugators. [p.19](#)
- When using thick paper (such as card stock), set the Paper Feed Pressure Adjustment Lever and the Paper Ejection Wing Adjustment Dial to “✕”, and open the two inner Paper Arrangers. [p.19](#)
- When using slippery paper, set the Paper Feed Pressure Adjustment Lever to “✕”. [p.19](#)
- Slide the Feed Tray Paper Guides, Receiving Tray Paper Guides, and Paper Stopper to fit the paper size. [p.19](#)
- Use flat printing paper that is free of folds. If curled paper is unavoidable, place the printing paper so that the curl faces down.
- Paper may stick to the drum surface if the top margin is too narrow on the original or if the upper portion of the original uses a large amount of ink. To solve this problem, lower the print position to provide a wider top margin or reverse the top and bottom of the original. Then restart printing from the beginning.

Storing Environment

Store printing paper in a level, dry area. Storing the paper in an excessively humid area can result in paper jams or poor print quality.

After unpacking printing paper, keep the remaining paper wrapped and store it in a moisture-proof box. It is highly recommended to put silica gel in the paper storage box.

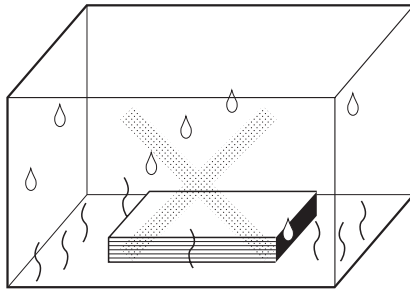

Originals

Size and Weight Restrictions

Usable originals are as follows.

Model	Using the Platen Glass		Using the Optional ADF unit	
	Size	Weight	Size	Weight
RZ370/RZ300	50 mm × 90 mm to 297 mm × 432 mm	Max. 10kg	90 mm × 140 mm to 297 mm × 432 mm	50g/m ² to 110g/m ²
RZ230/RZ200	50 mm × 90 mm to 257 mm × 364 mm		90 mm × 140 mm to 257 mm × 364 mm	

- Originals are scanned according to the size of paper placed on the Paper Feed Tray when masters are made; for the same width, the positions of the Feed Tray Paper Guides.
When the placed paper is smaller than an original, not the entire original will be scanned.
When the placed paper is larger than an original, dirt on the glass or shade of the original, for example, may result in unexpected dirt in the area beyond the size of the original.
- Bound originals can also be used on the Platen Glass.
- You can feed automatically up to 50 original sheets when using the optional ADF (Automatic Document Feeder) unit.

Note:

- Use the Platen Glass when printing the following originals:
 - Patched or worn originals
 - Wrinkled, curled, folded, or torn originals
 - Transparent originals (such as tracing paper or OHP transparencies)
 - Chemically treated originals (such as thermal or carbon paper)
 - Originals with correction fluid or glue
 - Extremely thin originals (less than 50 g/m²)
 - Extremely thick originals (greater than 110 g/m²)
 - Heavy drawing paper
 - Originals with staples or clips
- If an original is wrinkled, curled, or creased flatten it thoroughly so that the originals can be pressed directly onto the Platen Glass during processing.
- If correction fluid or glue is used on an original, thoroughly dry it before placement.
- For an original patched with thick paper, the shade of the patched paper may also be printed.

Before Starting to Use

Maximum Printing Areas and Margins

The maximum printing areas are as follows.

Model	Maximum Printing Area	Usable Maximum Print Paper Size
RZ370	291mm×413mm	297mm×432mm
RZ300	210mm×290mm	
RZ230	251mm×357mm	
RZ200	210mm×290mm	

Important!:

- No matter which size of originals is printed, the margins indicated on the figure are required for the originals. Reduce the original if necessary to fit it inside of the margins. Place an original so that its end having a 5 mm margin at least comes to the left of the Platen Glass.

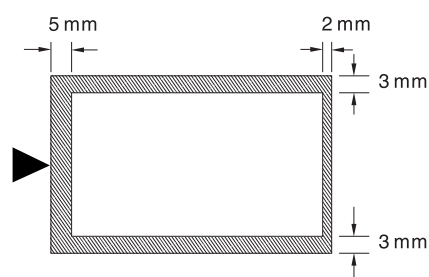

Materials Not to Be Printed

Do not use the machine in any manner which violates the law or infringes on established copyrights, even when making copies for personal use. Consult your local authorities for further details. In general, use discretion and common sense.

Preparing to Print

Setting up the Paper Feed Tray

1 Open the Paper Feed Tray.

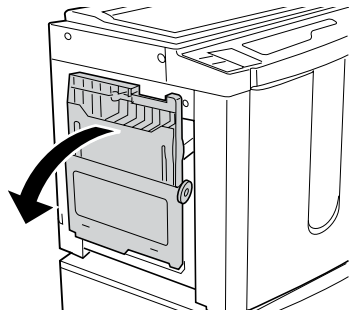

2 Load paper.

Place paper in the printing orientation, and slide the Feed Tray Paper Guides to fit to the sides of the paper. Then turn the right and left Feed Tray Paper Guide Levers to lock the guides.

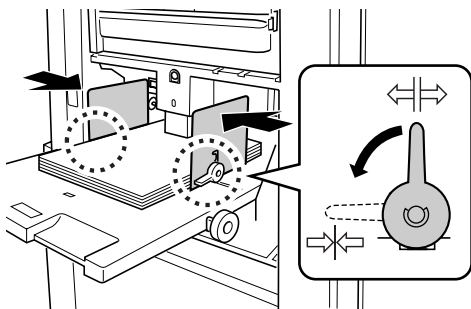

↔ :Unlock
 ⇨⇩⇨ :Lock

Important!:

- Do not use paper of inappropriate sizes nor mix paper of different sizes.
- Before sliding the Feed Tray Paper Guides, position its lock lever to ↔.

3 Select the paper feed pressure.

Position the Paper Feed Pressure Adjustment Lever according to the finish of the paper.

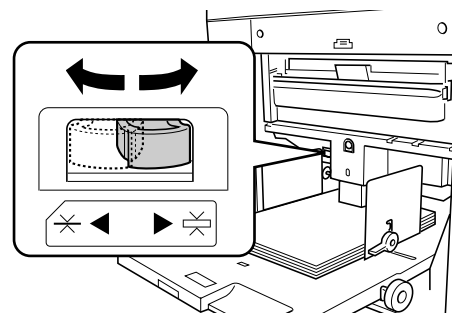

↔ :For standard paper
 ⇨⇩⇨ :For thick or smooth-surface paper

Note:

- Before closing the Paper Feed Tray, remove the paper and widen the Feed Tray Paper Guides to the limits.

Before Starting to Use

Adding or Replacing Paper

When you add paper or replace with paper of a different size at the time of printing, press the Feed Tray Descent Button to lower the Paper Feed Tray.

Pressing the button gently causes the tray to be lowered to the bottom. If you press and hold the button, the tray is lowered until you release the button.

When the tray runs out of paper or you remove all paper, the tray is automatically lowered to the bottom.

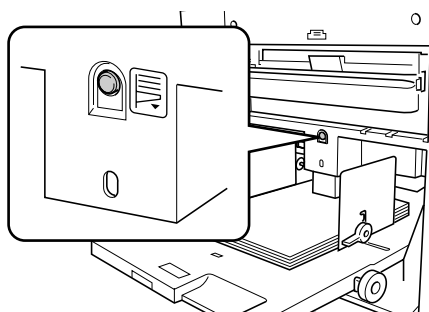

Important!

- Do not mix paper of different sizes.
- After replacing with paper of a different size, reposition the Receiving Tray Paper Guides and Paper Stopper according to the size of the replacement paper.

Setting up the Paper Receiving Tray

1 Open the Paper Receiving Tray.

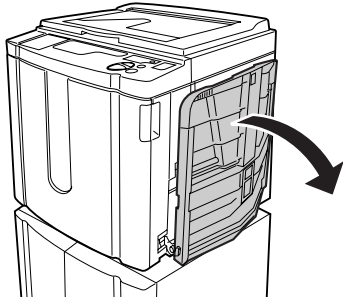

2 Position the Receiving Tray Paper Guides.

Raise the guides, hold their lower parts, and then slide them according to the width of paper.

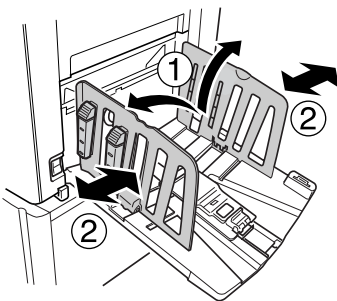

Important!:

- For thick paper such as drawing paper, position the Receiving Tray Paper Guides a little wider than the actual paper width.
- When you move the Paper Feed Tray using the Horizontal Print Position Adjustment Dial, reposition also the Receiving Tray Paper Guides. If the guides are not correctly positioned, a problem such as a paper jam can occur.

3 Raise the Paper Stopper, and then slide it according to the length of paper.

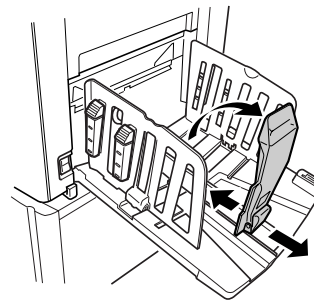

The subsequent steps differ depending on the models.

- For RZ3XX, go to step 4.
- For RZ2XX, go to step 6.

4 Adjust the Paper Arrangers. (For RZ2XX, unavailable)

Alignment of paper is affected by sizes and strength of paper. Adjust the Paper Arrangers so that printed paper is aligned.

● For ordinary paper

Press to open all of the four Paper Arrangers.

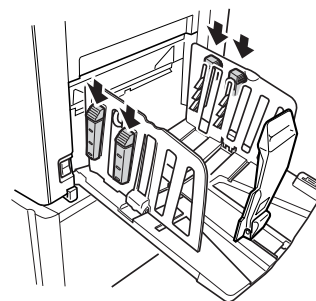

Before Starting to Use

- **For ordinary paper with images lopsided on page**
Press to open the two Paper Arrangers on the more heavily printed side.

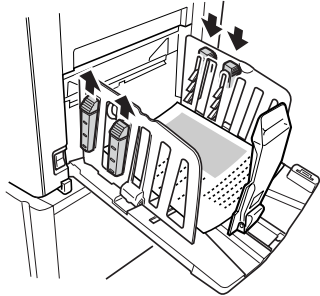

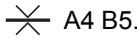
- **For ordinary paper smaller than B4**
Set to .

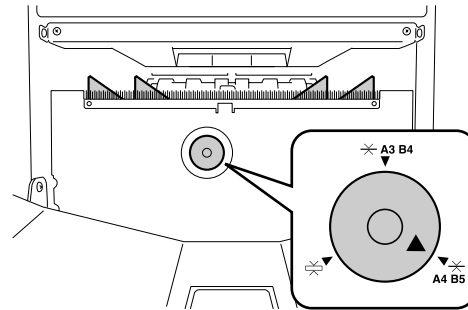

- **For thick paper**
Press to open the two Paper Arrangers (right and left) closer to the machine.

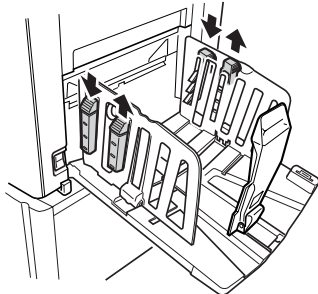

- **For thick paper**
Set to .

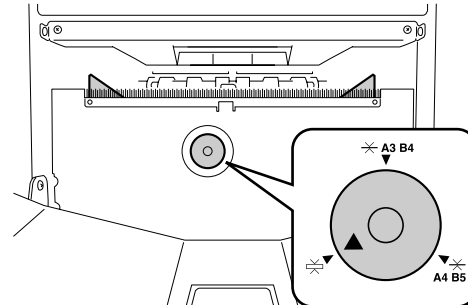

5 Adjust the Paper Ejection Wing. (For RZ2XX, unavailable)

Adjust the Paper Ejection Wing Adjustment Dial according to the type and size of paper.

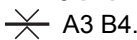
- **For ordinary paper equal to or larger than B4**
Set to .

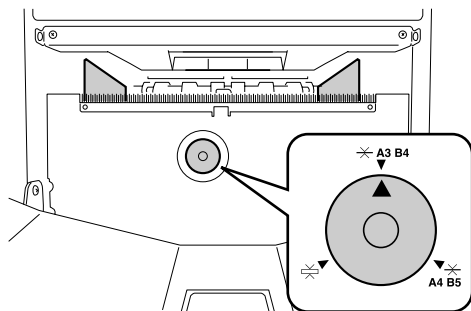

Note:

- When closing the Paper Receiving Tray, first slide the Paper Stopper to the edge of the tray and fold it inward. Then widen the Receiving Tray Paper Guides with the Paper Arrangers closed and fold the guides inward.

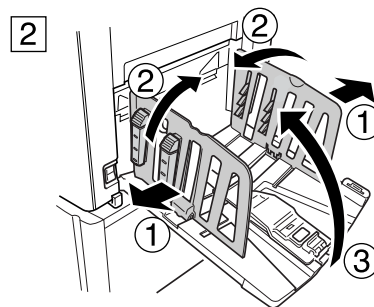
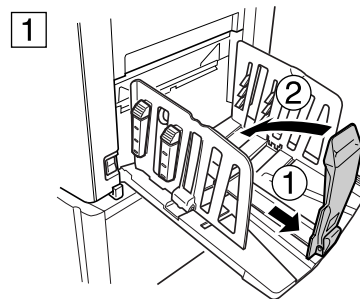

6 Set the corrugators. (for RZ3XX, unavailable)

Lower the corrugators to the inside of the Paper Guides.

Note:

- Usually the corrugators should be lowered. When using thick paper, you need not lower the corrugators.

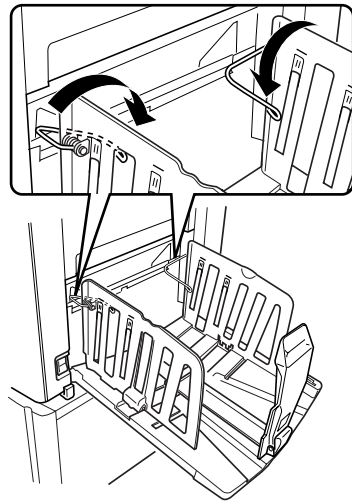

Note:

- When closing the Paper Receiving Tray, first slide the Paper Stopper to the edge of the tray and fold it inward. Then raise the corrugators, widen the Receiving Tray Paper Guides, and fold the guides inward. Last close the Paper Receiving Tray.

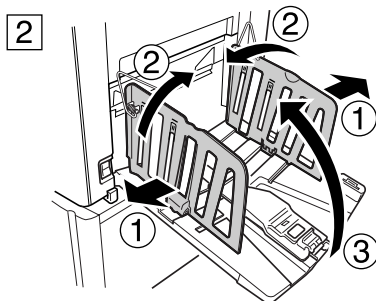
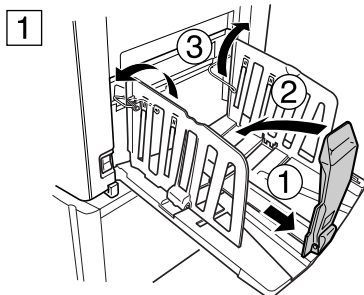

Basic Operations

Safety Guide - Handling and Operation

This section describes the precautions to be observed when handling the machine. Read this section before operating the machine.

Operation Environment

Important!:

- Operate the machine under the following appropriate environment conditions.
Temperature range: 15°C to 30°C
Humidity range: 40% to 70% (noncondensing)

Machine Handling

⚠ WARNING:

- Do not place water containers or metallic objects on the machine. Fire or electric shock may occur if water or metallic objects fall into the machine.
- Do not insert any metallic material or flammable substance into the machine through any opening. This can result in fire or electric shock.
- Do not remove machine covers. Exposing internal parts may result in electric shock.
- Do not disassemble or rebuild the machine by yourself. This can result in fire or electric shock.
- If the machine emits excessive heat, smoke or foul odor, immediately turn off the POWER, unplug the power cord and contact your service representative. Failure to do so can result in fire or electric shock.
- If something drops inside the machine, immediately turn off the POWER, unplug the power cord and contact your service representative. Failure to do so can result in fire or electric shock.
- Never stick your hands or fingers in the openings of the machine during operation.
- Keep loose clothing or long hair away from moving parts to avoid becoming entangled.
- Do not place heavy objects on the machine. The objects might fall and cause injury.
- Contact your service representative before moving the machine.

⚠ Caution:

- Do not open any covers or move the machine during operation.
- Unplug the power cord, if you do not use the machine for a long time.
- The machine has precision parts and driving parts inside. Do not handle the machine in other ways than described in this guide.
- Do not apply any shock to the machine.

Important!:

- Do not unplug the power cord or turn off the power during operation.
- Be sure to open and close all machine covers gently.

Consumables

Important!:

- For ink and master Roll, it is recommended to use the products specified by RISO.
- Store consumables such as master Roll and ink properly.
Do not store consumables in the following places:
 - Locations that are subject to direct sunlight or bright locations that are close to windows
(If there is no other choice, curtain the window.)
 - Locations that are subject to rapid changes in temperature
 - Extremely hot and humid locations or extremely cold and dry locations

Ink Handling

⚠Caution:

- If ink gets into your eyes, flush it out immediately with plenty of water. If irritation continues, seek medical attention.
- If ink comes into contact with your skin, wash it off thoroughly using soap.
- Allow plenty of ventilation during printing.
- If you feel unwell during use, seek medical advice.
- Only use the ink for printing purposes.
- Keep the ink out of the reach of children.

Basic Operations

Basic Process

The machine presents two basic operational processes; master-making process and printing process.

● Process for printing from a paper document or book

A placed original is scanned by the scanner, and a generated master is rolled around the Print Drum. After a while, sample copy is performed. After checking the print result, enter the number of copies to be printed and start printing.

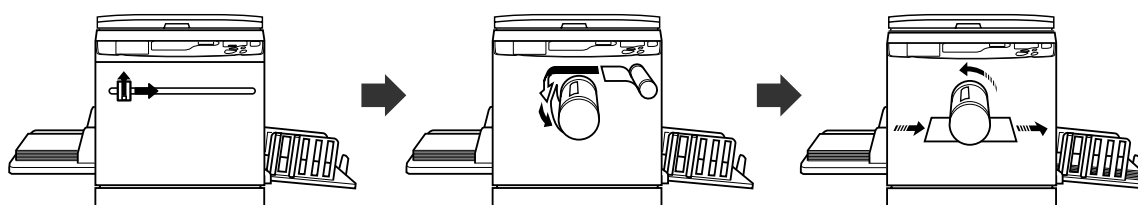

● Process for printing with data generated using a computer

Data sent from a computer is transformed into images, and a generated master is rolled around the Print Drum. You can send instructions for printing from the computer (through the printer driver).

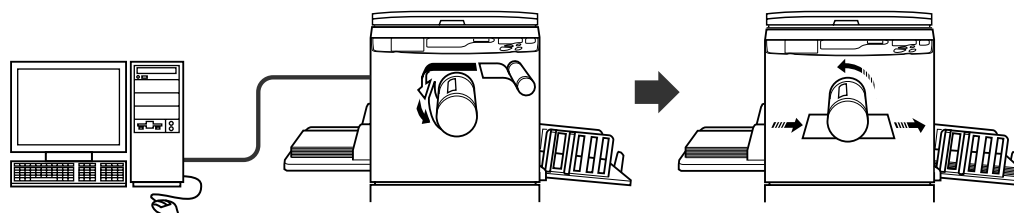

Important!:

- Some optional kits are needed for connection with a computer.
☞ p.14

Basic Operations

Printing from a Paper Document or Book

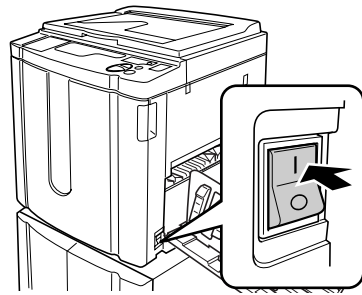

1 Set the power switch to I (ON) to turn the power on.

The power switch is located on the lower right side of the machine.



I : Power On
O : Power Off

Important!:

- When the machine is in the Energy Saving mode, the  key is lighted. Press the  key to wake up the machine.

Note:

- If data is received from a computer while the machine is being operated, that data may be given a higher priority for making a master. To give a higher priority to an original placed on the machine, press the  key to turn off its indicator.

2 Check the display.

Check that any Check & Error Display section is not lighted nor blinking.

 p.82

Note:

- When the  indicator is lighted, idling action is activated just before the master-making operation.
 p.55

3 Place an original.

● **When placing on the Platen Glass**

Open the Platen Cover and place the original face down. Align the centre of the original with the mark on the left-hand side of the glass. After placing the original, slowly close the Platen Cover.

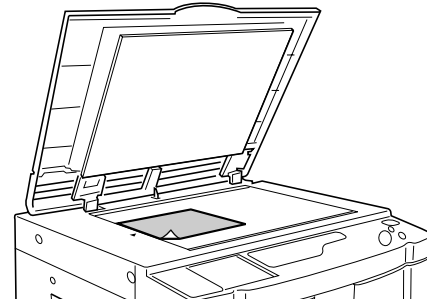

Note:

- When placing an original is completed, the master-making process is automatically started; the Master-Making indicator on the Control Panel lights. If the indicator is not lighted, press the  key.
- **When placing in the ADF unit (Option)**
Place originals face down, and then adjust the ADF Original Guides to the width of the originals.

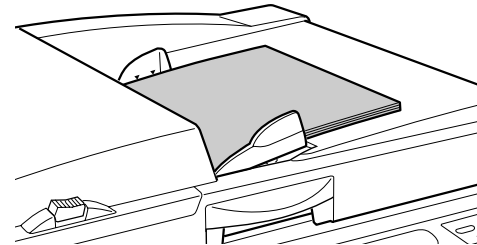

Important!:

- The sizes of originals to be placed in the ADF unit must be 90 mm x 140 mm at least. For smaller originals, use the Platen Glass.

Note:

- You can place up to about 50 sheets of originals in the ADF unit.

Basic Operations

- If using the Custom Setting mode you select ON for Semi-Auto, the next master-making is automatically started and then the machine will stop when the ADF unit contains originals.
☞ p.59

4 Make necessary settings.

Make various settings including image processing mode selection.
☞ p.32~p.44

5 Enter the number of copies to be printed, using the Print Quantity keys.

The specified number is shown on the Print Quantity Display.

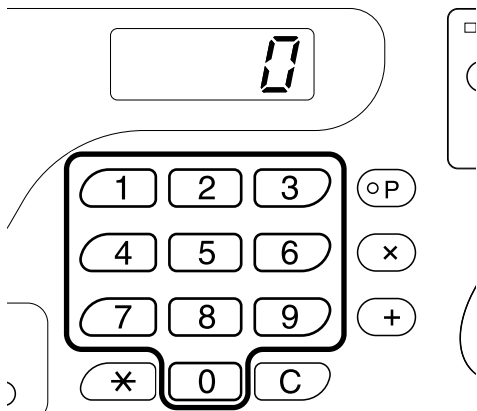

Note:

- If you enter an incorrect number, press the [C] key, and then enter the correct number.
- If "L" appears at the left end of the Print Quantity Display, printed copies are output from a Linked Printer (option).
Go to step 7.
☞ p.57
- In order to make a master using the machine when "L" is in display, press the [C] key to reset the Print Quantity Display to zero, and then press the \diamond key. The master-making process is started.
Check the sample copy result, enter the number of copies to be printed, and then press the \diamond key again.

6 Press the \diamond key.

The original is scanned, and a master is made. After a master has been made, a sample copy is printed.
Check the sample copy result; e.g., print position and density.

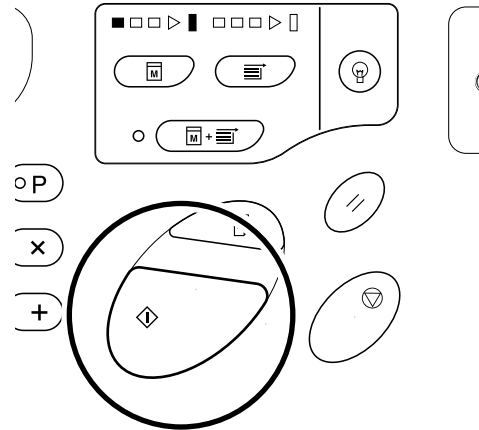

Note:

- You can change the settings for print position and density. After changing the settings, press \square , and then check the proof copy result.
☞ p.46~p.50

7 Press the \diamond key again.

The specified number of copies is printed.

Note:

- You can change the print speed using the Print Speed Adjustment keys.
☞ p.50
- If printing is stopped halfway, check the display.
☞ p.82~p.92

8 Press the \parallel key.

After printing has been finished, return the settings to the initial settings.

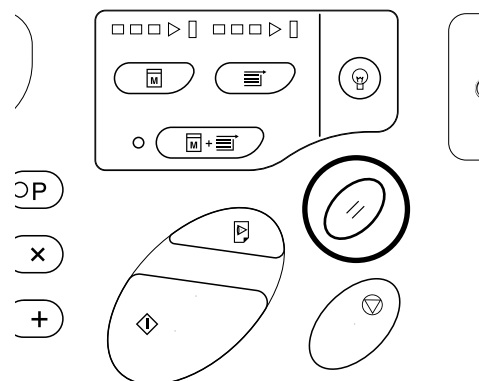

9 Remove the printed paper.

Pull and open the Receiving Tray Paper Guides, and then remove the paper.

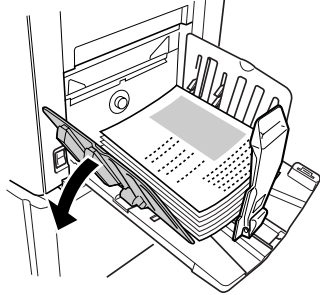

Note:

- For RZ2XX, lift the corrugators and pull the guides open.

Tip:

- Depending on the operation status of the machine, different Progressive Arrow sections light or blink.

Progress Arrows

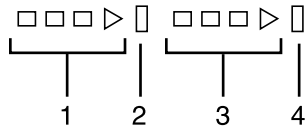

- 1) Master-making progress arrow
- 2) Master-making stop bar
- 3) Printing progress arrow
- 4) Printing stop bar

- Arrow 1 blinks and increments by one segment: Master-making process in progress
- Arrow 3 blinks and increments by one segment: Printing process in progress
- The stop bar lights: Indicating Stop timing
- Both 1 and 2 light: Master-making process can be executed.
- Both 3 and 4 light: Printing process can be executed.
- Both 1 and 4: In the Auto-Process mode
- The machine halts and halfway arrow segments blink: A restoration instruction is being waited.

Basic Operations

Printing with Data Generated by a Computer (Optional Kit Required)

1 Set the power switch to I (ON) to turn the power on.

The power switch is located on the lower right side of the machine.

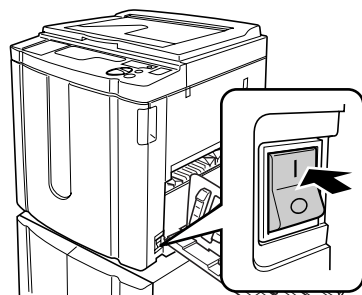

I : Power On
O : Power Off

Important!:

- When the machine is in the Energy Saving mode, the key is lighted. Press the key to wake up the machine.

2 Check that the indicator is on.

If the indicator is off, press the key.

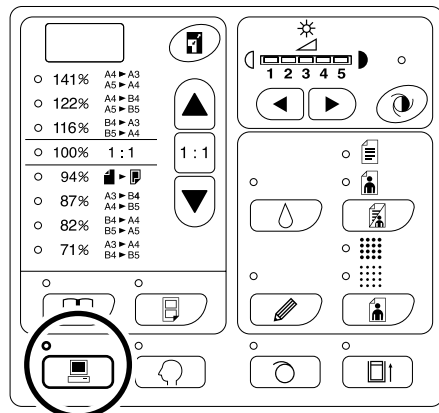

3 Check the paper and drum colour.

To change the paper or drum colour, replace the paper on the Paper Feed Tray or replace the colour print drum as needed.

4 Send document data from the computer.

While the machine is receiving data, the indicator blinks.

When receiving is completed, the master-making process is started.

Important!:

- You cannot make various settings including image processing mode, by operating the machine. Only the printer driver allows such settings. For details, see the user's guide of the printer driver.

Note:

- You can also use the printer driver to stop the master-making or printing process at any point. For details, see the User's Guide of the printer driver.
- By checking which Progress Arrow segments light or blink, you can identify at which status the machine is stopped. [p.29](#)
When the machine has been halted with Progress Arrow segments blinking, it is waiting for a start instruction. Press the key to resume the process indicated by the blinking arrow segments.
- If you press the key when the machine is not in use after the master-making process or when you stop the machine during printing, the page number currently being printed will be displayed in Print Quantity Display.

Tip:

When the computer sends document data, the machine automatically receives it and starts the master-making process. It is judged whether or not the machine is in use, based on how much time elapsed after any key had been pressed last or printing had been finished.

This time period is called the "Reservation Period".

You can change the initial setting for the occupied time in the Custom Setting mode.

[p.59](#)

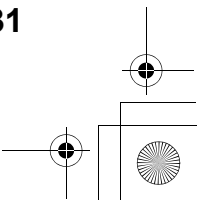
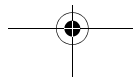
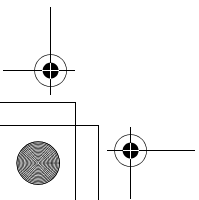
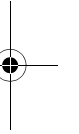
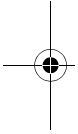
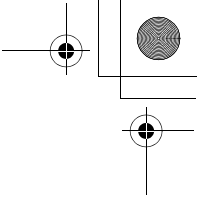
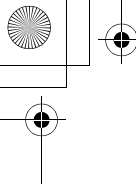



Setting up for Scanning Originals

Selecting the Image Processing Mode [Line, Photo, Duo]

In order to make a quality master, select an appropriate mode depending on whether originals contain only Line(text) or photo or both of them.

Press the  key to select the Image Processing mode.

Each time you press the key, the indicators light in the order;  (Line)→ (Photo)→ (Duo)

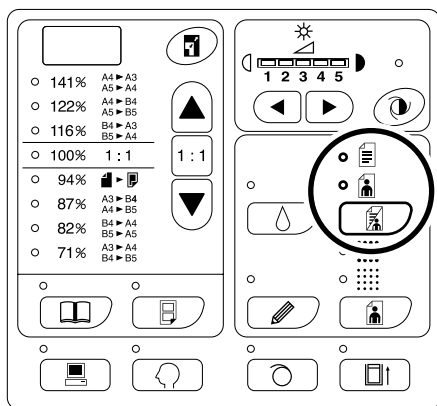



Important!:

- With the Photo mode or Duo mode selected, you can process images with a dot screening when printing. (For RZ2XX, unavailable)
☞ p.34
- With the Photo mode or Duo mode selected, you cannot select “Auto” for the scanning level. Perform manual adjustment.
☞ p.37
- You cannot use the Image Processing mode and Pencil mode together.

Note:

- Select the Pencil mode when printing from an original written with a pencil or a stamped original.
☞ p.33
- The Custom Setting mode allows you to change the initial setting for the Image Processing mode.
☞ p.59

The table shows which types of originals are appropriate for each mode.

Mode	Type of Originals
 Line	Only text contained; e.g., word processing file printout, newspaper
 Photo	Only photos contained
 Duo	Both text and photos contained

Scanning Originals Written with Pencils [Pencil] (For RZ2XX, unavailable)

This function allows clearer printing from such originals containing faint contents as those written with pencils.

Press the  key to turn on its indicator.

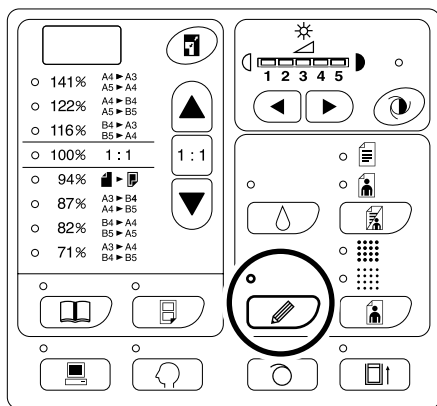

Important!:

- You cannot use the Pencil mode and Image Processing mode at the same time.
 - You cannot use the Pencil mode and Dot Process mode at the same time.
 - When in the Pencil mode, adjust the scanning level manually. You cannot select "Auto" (for RZ2XX, unavailable).
-  p.37

Note:



- To clear the Pencil mode, press the  key again to turn off its indicator or select another image processing mode.

Setting up for Scanning Originals

Processing Photos with Dot Screening [Dot Process] (For RZ2XX, unavailable)



This function processes photo originals with dot screening, resulting in clearer printing. You can select the dot screening pattern from two types.

Press the  key to select the type of a dot screening.

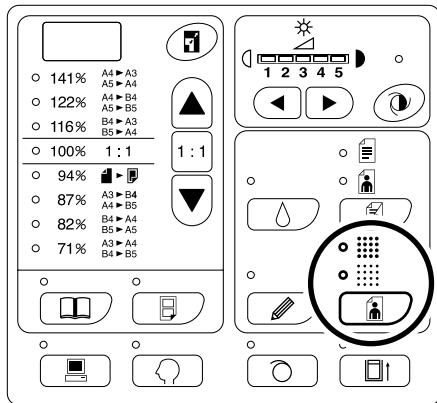
Each time you press the key, the indicators light in the order;  (COARSE) →  (FINE) → and then OFF.



The table shows the equivalent lpi (line per inch) to each mode:

Mode	Equivalent Lpi
 COARSE	53
 FINE	106

Important!:

- You cannot use the Dot Process mode and Line mode together.
- You cannot use the Dot Process mode and Pencil mode together.

Enlarging and Reducing Originals [Enlargement/Reduction]

You can enlarge or reduce originals when printing.
Specify the enlargement/reduction ratio by selecting the standard ratios; or specify it in increments of 1%.

Enlarging and Reducing by Standard Ratios [Standard]

Select the standard ratios when enlarging or reducing standard-sized originals to another standard size or when increasing margins around the original.

Press the ▲/▼ keys to specify the enlargement/reduction ratio.

Each time you press the key, the indicator of the selected ratio lights.

To restore 100%, press the 1 : 1 key.

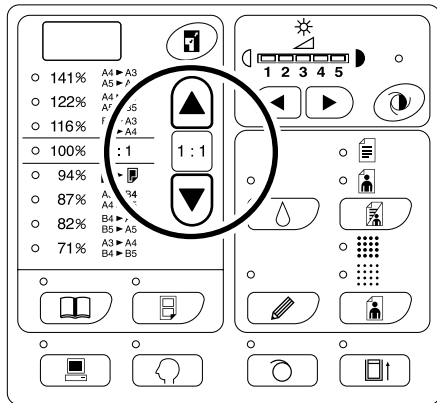

The standard enlargement/reduction ratios differ among the models.
Check the panel on your machine.

Setting up for Scanning Originals

Enlarging and Reducing with the Zoom Function [Zoom] (For RZ2XX, unavailable)

Specify the enlargement/reduction ratio between 50% and 200% in increments of 1%.

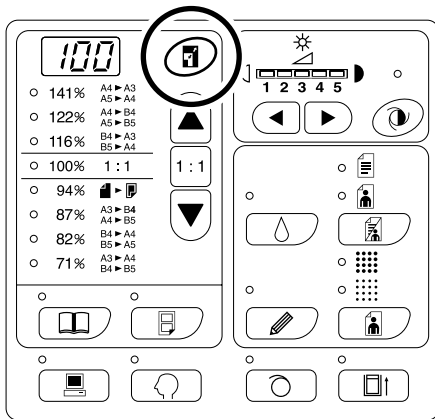

1 Press the key to select the Zoom mode.

The current enlargement/reduction ratio is shown on the display.



2 Press the / keys to select the enlargement/reduction ratio.

The selected enlargement/reduction ratio is shown on the display.

-  key: Each press increases the ratio by 1%.
-  key: Each press decreases the ratio by 1%.

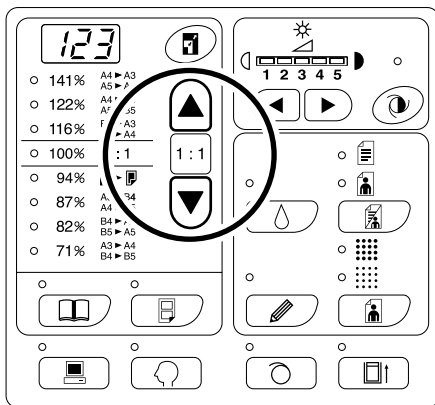

Note:

- To restore 100%, press the  key or the 1 : 1 key.



Scanning Originals Having Faint or Dark Contents [Scanning Level Adjustment]

You can adjust the scanning level according to the density of text and images on originals.
 With "Auto" selected, the density of originals is pre-scanned and the optimum scanning level is automatically set (for RZ2XX, unavailable).
 Manual adjustment allows you to select from five levels.
 For originals containing faint text, select a high level (4 or 5). For such coloured originals as newspapers, select a low level (1 or 2).

Press the  key or the /  keys under  to adjust the scanning level.

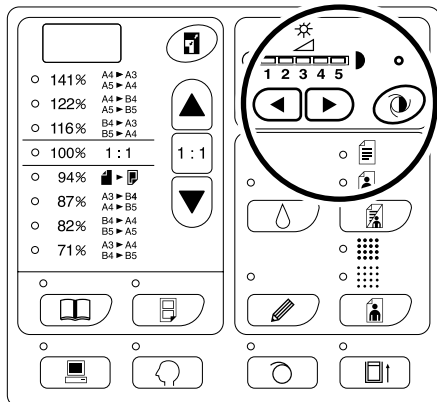
- ◀ key: Each press decreases the scanning level.
- ▶ key: Each press increases the scanning level.



-  :Auto (for RZ2XX, unavailable)
-  :Lighter
-  :Darker

Important!:

- With the scanning level adjusted, print several copies after remaking masters to check the print result.
- You can select "Auto" only for the Line mode. You cannot select "Auto" with the Photo or Duo mode selected.

Note:

- The Custom Setting mode allows you to change the initial setting for the scanning level.
 ☞ p.59

Setting up for Scanning Originals

Reproducing Bound Documents [Book Shadow Edit]

This function erases the binding “spine” shadow when printing from such bound originals with facing pages as magazines and books.

Important!:

- The initial settings have been made for the size of originals whose masters can be made and the width of shadow to be erased.
(Initial settings: for the size of originals, size of paper placed on the Paper Feed Tray; for width of shadow to be erased, 20 mm)
The Custom Setting mode allows you to change the initial settings for the size of originals and the width of shadow to be erased. [p.59](#)
- If using the Custom Setting mode you have selected “Paper” as the Size of originals for Book shadow editing, use regular-sized paper. If you place custom-size paper, shadow erasure is not correctly performed.
- The outside of the set original size is not scanned and used for the master-making process.

1 Place a book (or a magazine) on the Platen Glass.

Make sure to place the original in the orientation below:
The shadow within the dotted box is erased.

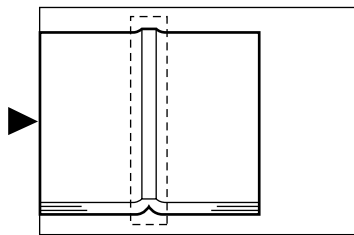

2 Press the  key to turn on its indicator.

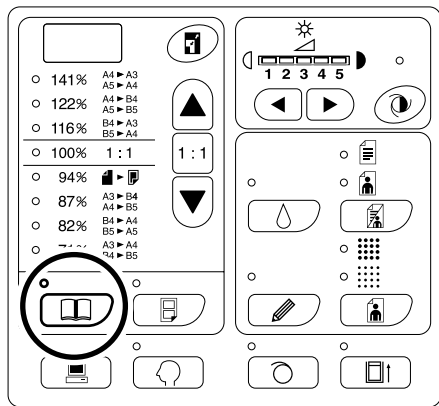

Note:

- To clear the setting, press the  key again to turn off its indicator.

Printing Originals Side-by-Side [2-Up Printing]

The same or different originals can be printed side by side.

This is called 2-Up printing.

2-Up printing allows you to place a single original or two different originals

Important!:

- With custom size paper placed, you cannot perform 2-Up printing. Quit 2-Up printing or place regular-sized paper.

Single-Original Printing and Two-Original Printing

1 Single-original printing

This prints from the same original and outputs onto a single sheet of paper side by side.

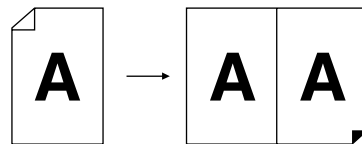

2 Two-original printing

This prints from two different originals and outputs onto a single sheet of paper side by side.

The centre of printed copies will be free from the shade of originals.

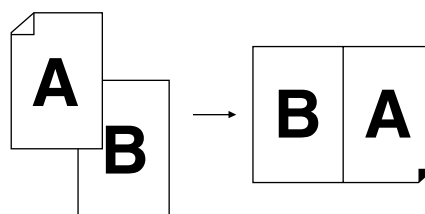

Important!:

- For two-original printing using the Platen Glass, the machine requires a certain period of time before placing the second original. Using the Custom Setting mode, select 15 seconds or 30 seconds for the interval time; the initial setting is 15 seconds.

[p.59](#)

Note:

- When using the ADF unit (option) for two-original printing, you can place two piled originals in the ADF unit. The two originals are continuously scanned for 2-Up printing.

Setting up for Scanning Originals

Restrictions on 2-Up Printing

2-Up printing restricts the sizes of paper to be used, paper orientations, and the enlargement/reduction ratios.

Enlargement/reduction ratio

The table shows enlargement/reduction ratios suitable for 2-Up printing.

		Original			
		A4	B5	A5	B6
Print Paper	A3 (for RZ2XX, unavailable)	100%	116%	141%	163%
	B4	87%	100%	122%	141%
	A4	71%	82%	100%	116%
	B5	<u>61%</u>	71%	87%	100%

==:For RZ2XX, you cannot make selections.

Paper orientation

Before printing, check the orientations of the original and print paper.

- **Orientation of originals**

Always place originals in the orientation below.

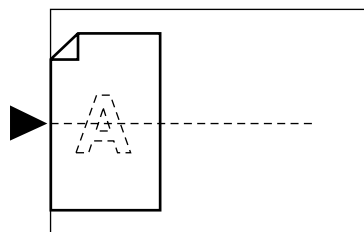

- **Orientation of print paper**

Always place print paper in the orientation below.

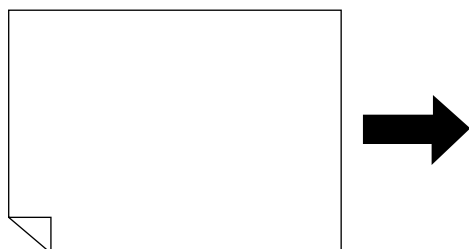

Note:

- You can specify the enlargement/reduction ratio by selecting the standard ratios or specify it in increments of 1% using the Zoom function.
☞ p.35
- Originals must have sufficient margins. Insufficient margins result in inappropriate page layout.
☞ p.18
- Original margins are kept regardless of the enlargement/reduction ratio.
- For two-original printing, you can separately select the following functions for each original.
Image Processing mode, Pencil, enlargement/reduction ratio, dot process/scanning level

Operational Procedure

1 Place an original.

● **When placing on the Platen Glass**

Place the original face down in the vertical orientation. Position it using the mark on the left-hand side of the glass.

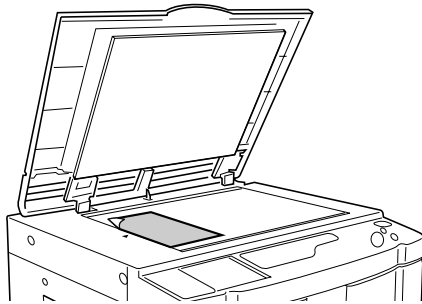

● **When placing in the ADF unit (Option)**

Place piled originals in the ADF unit. If you want to separately set the type and size of originals for each original, place one original at a time.

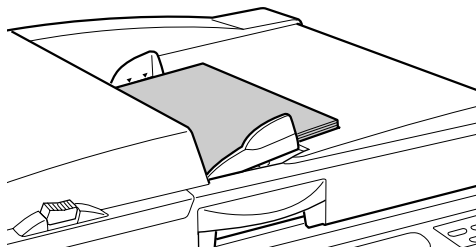

Important!:

- The sizes of originals to be placed in the ADF unit (option) must be 90 mm × 140 mm at least. For smaller originals, use the Platen Glass.

2 Press the key to turn on its indicator.

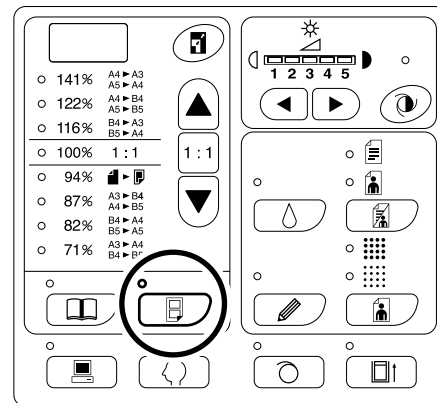

Note:

- To clear the mode, press the  key again to turn off its indicator.

3 Make necessary settings.

As necessary, make various settings including Image Processing mode selection.
☞ p.32~p.37

Setting up for Scanning Originals

4 Start the master-making process.

● When placing originals on the Platen Glass

● Single-original printing

Press the \diamond key to start the first scan. After the scan a interval time alarm sounds. Before the alarm stops, press the \diamond key again.

Important!:

- If you do not press the \diamond key within the interval time, the half of the print will be blank.

Note:

- If you select no interval time using the Custom Setting mode, you can complete 2-Up printing by pressing the \diamond key only once.
p.59

● Two-original printing

Press the \diamond key to start the first scan. After the scan a interval time alarm sounds. Before the alarm stops, place the second original, make various settings (if necessary), and then press the \diamond key again.

Important!:

- If you do not press the \diamond key within the interval time, the half of the print will be blank.

● When placing originals in the ADF unit (option)

● Single-original printing

Press the \diamond key to start the first scan. Place the second original within the interval time. Scan of the second original is automatically started.

Note:

- If you have selected no interval time using the Custom Setting mode, you cannot perform single-original printing with the ADF unit.

● Two-original printing

Place two piled originals in the tray. Press the \diamond key to sequentially execute 2-Up printing using the two originals. If you want to make different settings for each original, place only the first original, and then press the \diamond key. Within the interval time, change the settings, and then place the second original. Scan of the second original is automatically started.

5 Enter the number of copies to be printed, using the Print Quantity keys.

The specified number is shown on the Print Quantity Display.

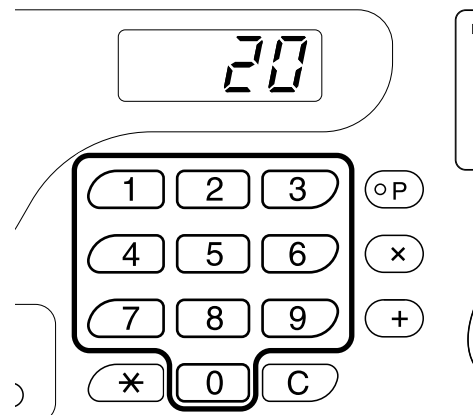

6 Press the \diamond key.

2-Up printed copies are output.

Note:

- If there exists an original in the ADF unit when "Auto-Process" is "ON" for two-original printing, 2-Up printing is sequentially executed.



Automatic Printing [Auto-Process]

With "Auto-Process" selected, enter the number of copies to be printed, and then press the  key. The master-making and printing processes are automatically executed in a sequence.

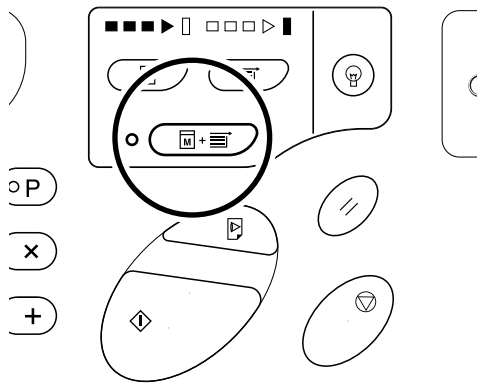
Press the  +  key to turn on its indicator.



Note:

- When Auto-Process is selected and printing process is finished, Print Quantity Display returns to show the number of copies entered before printing.
- To clear the mode, press  +  key again to turn off its indicator.
- If you place multiple originals in the ADF unit (option), pressing the  key causes the placed originals to be automatically printed for the specified number of copies.
- Using the Custom Setting mode, you can make such a setting that "Auto-Process" is always set to "ON" when you reset or start the machine.

 p.59

Setting up for Scanning Originals

Saving Ink [Ink Saving]

Setting the Ink Saving mode before making masters will allow the machine to save ink when printing. Because of ink consumption save processing, the print density will be lower than usual.

Press the  key to turn on its indicator.

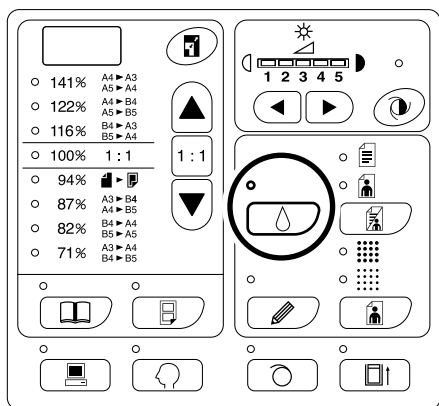

Important!:

- When using this mode, you cannot adjust the scanning level.
- You cannot adjust the print density when printing.
- You cannot set this mode to print the data created with a computer.

Note:

- To clear the mode, press the  key again to turn off its indicator.

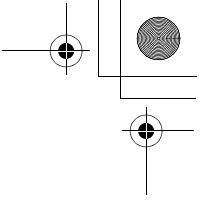
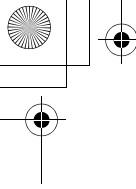

Setting up for Scanning Originals

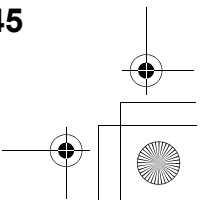
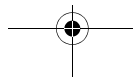
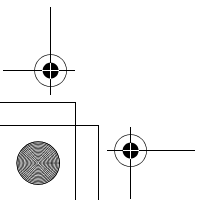
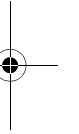
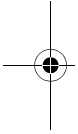

Setting up for Printing

Producing Proof Copies [Proof]

After adjusting the print position and density, you can produce proof copies to check the print quality.

Press the  key.

Proof copy does not affect the number shown on the Print Quantity Display.

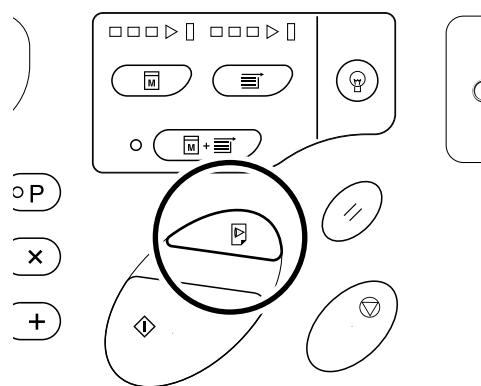

Note:

- By holding down the  keys, you can continuously perform proof copy.

Adjusting the Print Density [Print Density Adjustment] (For RZ2XX, unavailable)

You can select the print density from five levels.

Press the ◀/▶ keys under  to adjust the print density.

Each time you press the key, the print density is changed by one step.

◀ key: Decreases the print density.

▶ key: Increases the print density.

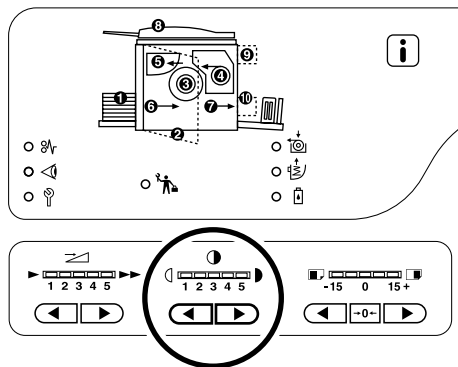

:Lighter

:Darker

Important!:

- With the Ink Saving mode selected, you cannot adjust the print density.

Note:

- The Custom Setting mode allows you to change the initial setting for the print density.

☞ p.59

Setting up for Printing

Adjusting the Print Position [Print Position Adjustment]

Use the Vertical Print Position Adjustment keys to adjust the print position in the vertical direction; and use the Horizontal Print Position Adjustment Dial to adjust it in the horizontal direction.

Adjustment range Vertical direction: $\pm 15\text{mm}$ Horizontal direction: $\pm 10\text{mm}$

Important!:

- After adjusting the print position, perform proof copies to check the new print position.
p.46

Adjusting the Vertical Position

Press the **◀/▶** keys to adjust the vertical position.

◀ key: Each press shifts the print position downward in steps of about 0.5 mm.

▶ key: Each press shifts the print position upward in steps of about 0.5 mm.

→0← key: Returns the print paper to the original position.

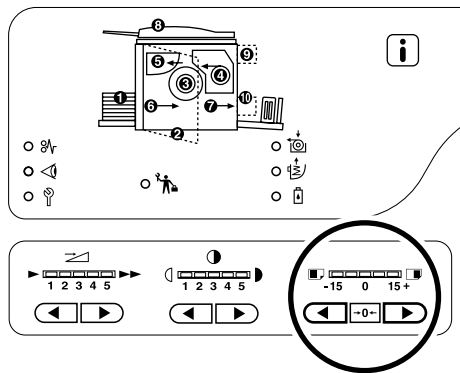

- ◀ : Shifts the print position downward.
- ▶ : Shifts the print position upward.

Adjusting the Horizontal Position

1 Press the Feed Tray Descent Button to lower the Paper Feed Tray.

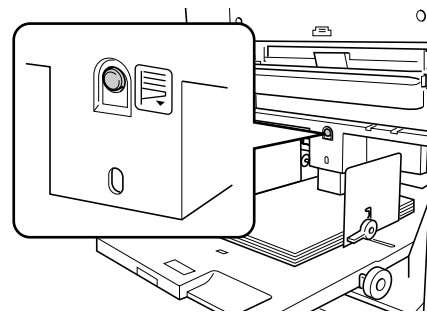

2 Turn the Horizontal Print Position Adjustment Dial beside the Paper Feed Tray to adjust the horizontal position.

Turn the dial upward to shift the print position to the left, and turn the dial downward to shift it to the right.

You can check the offset amount from the centre, through the scale marks beside the Paper Feed Tray.

▲ on the scale indicates the centre.

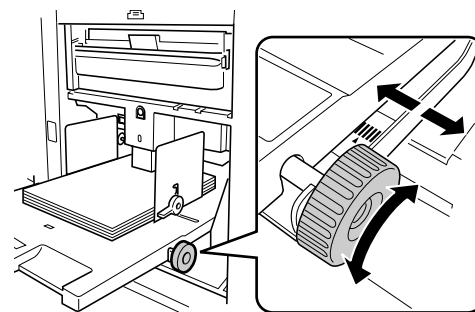

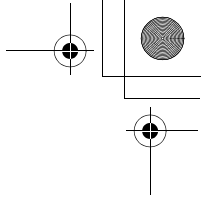
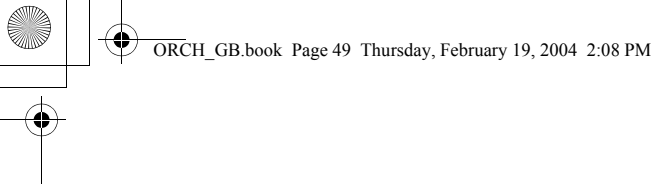

Setting up for Printing

Important!:

- If you have adjusted the horizontal position, also adjust the Receiving Tray Paper Guides.
- If you have adjusted the horizontal position, make sure to reset to the centre after printing is finished.

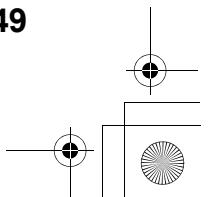
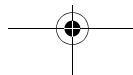
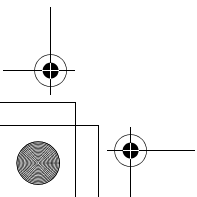
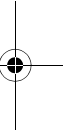
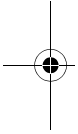

Setting up for Printing

Changing the Print Speed [Print Speed Adjustment]

You can select the print speed from five levels; 60 copies per minute to 130 copies per minute.

Press the ◀/▶ keys under  to select the print speed.

Each time you press the key, the print speed is changed by one step.

- ◀ key: Decreases the print speed.
- ▶ key: Increases the print speed.

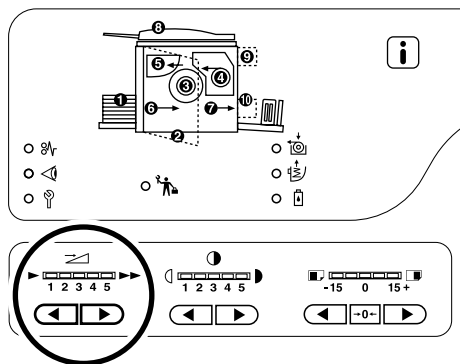

- ▶: Slower
- ▶▶: Faster

The table shows the relationship between the indicator segment position and print speed.

Segment Position	1	2	3	4	5
Print Speed (Number of copies per minute)	Approx. 60	Approx. 80	Approx. 100	Approx. 120	Approx. 130

Note:

- The Custom Setting mode allows you to change the initial setting for the print speed.
p.59

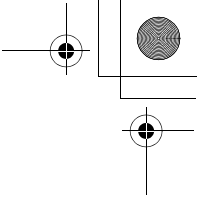
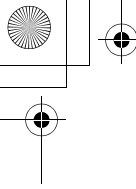

Setting up for Printing

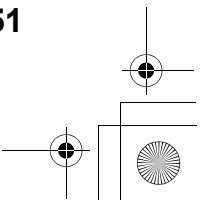
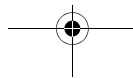
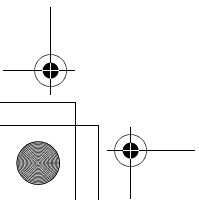
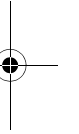
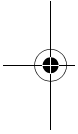

Advanced Features

Automatic Sorting into Groups [Programmed Printing]

From a single sheet of original, this function prints and sorts into various groups having different number of copies per set and/or different number of sets.

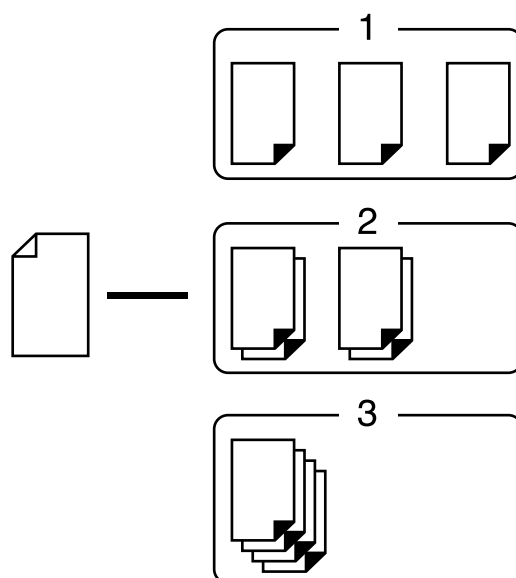

Note:

- Up to five groups can be set up, with a maximum of 99 sets and a maximum of 9999 copies in each group.
- The Job Separator (option) is useful for Programmed Printing.
- If you place more than one original in the ADF unit (option) with "ON" selected for "Auto-Process", the programmed routine is repeated for each original.

1 Press the [P] key to turn on its indicator.

The print quantity entry mode is started.

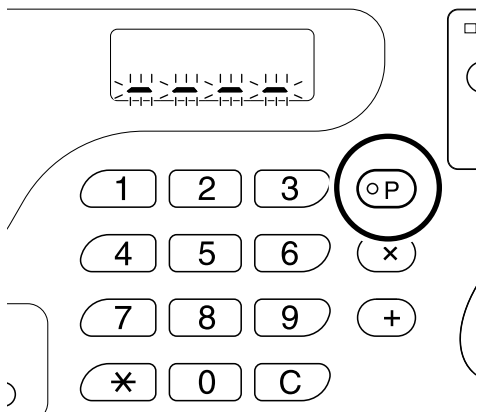

Note:

- To clear the mode, press the [P] key again to turn off its indicator.
- If the mode is quitted, the setting is cancelled.

2 Enter the number of copies to be printed, using the Print Quantity keys.

Enter the number of copies for the first group.

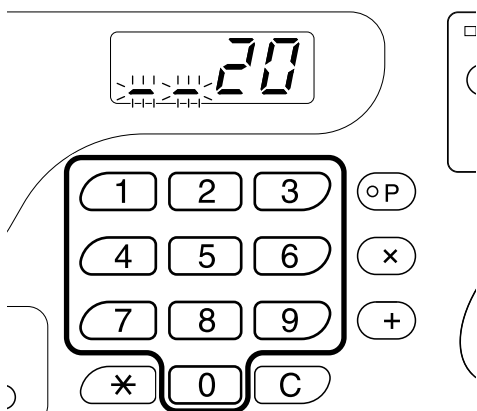

Note:

- If you enter an incorrect number, press the [C] key to clear the number, and then enter the correct number.

3 Press the [X] key.

The set quantity entry mode is started.

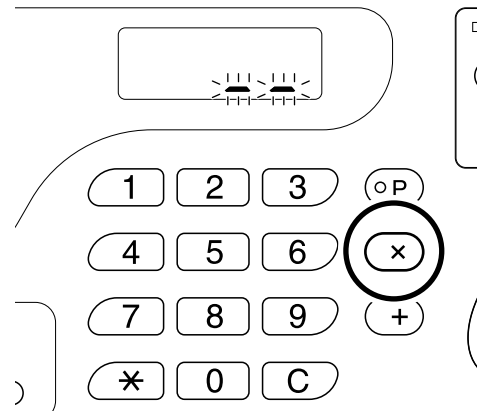

4 Enter the number of set using the Print Quantity keys.

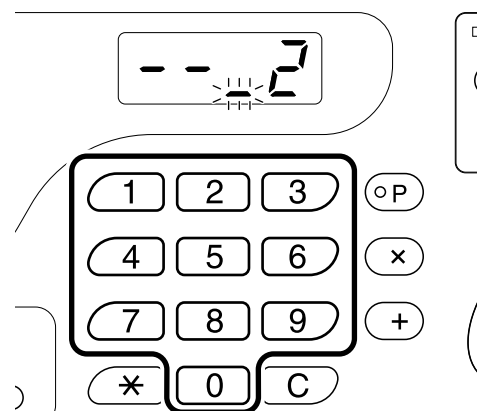

To set the next group, go to step 5.
To finish the setting and start printing, go to step 6.

Note:

- If you enter an incorrect number, press the [C] key to clear the number, and then enter the correct number.
- If you do not enter a number, 1 is selected.

Advanced Features

5 Press the [+] key.

The machine then allows you to enter the number of copies for the second group.

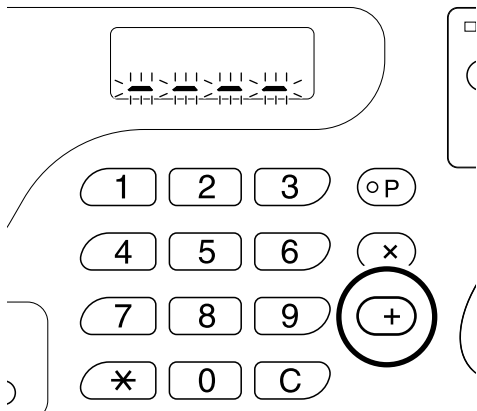

Repeat steps 2 through 5 to specify the number of copies and sets for each group.

6 Place an original.

● **When placing on the Platen Glass.**

Place an original on the Platen Glass face down and align its centre with the mark on the left-hand side of the glass.

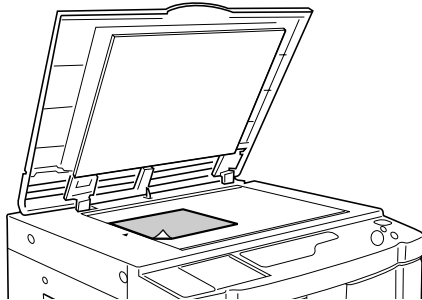

● **When placing in the ADF unit (option)**

Place originals and adjust the Original Guides to the width of the originals.

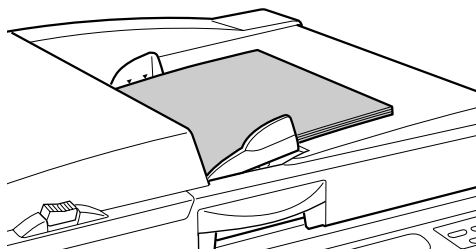

7 Make necessary settings.

Make various settings as necessary. You can set the following functions:

- Image Processing mode
- Pencil
- Dot Process
- Scanning level
- Enlargement/reduction ratio
- Auto-Process

8 Press the \diamond key.

A proof copy is printed. Check the print result; and if necessary adjust the print position and other items.

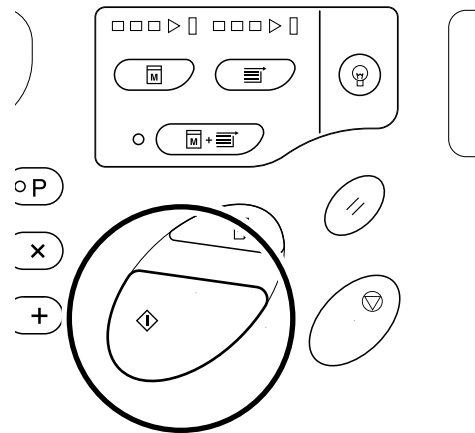

9 Press the \diamond key again.

Printing is started with the last programmed group.

Important!:

- When printing is finished for all groups, the programmed content is cleared. However, it is not cleared when "Auto-Process" has been set to "ON".

Note:

- Printing is stopped each time a routine for one set is finished. If you do not use the Job Separator (option), remove printed copies from the Paper Receiving Tray or put separation paper.
- To interrupt printing, press the ∇ key. Press the \diamond key again to resume printing.

Idling Action [Idling]

Idling action prevents the machine from printing the first several copies with faint ink after the Print Drum has been exchanged or the machine has not been used for an extended period of time. Idling action before the master-making process assures consistent print quality from the start.

Press the  key to turn on its indicator.

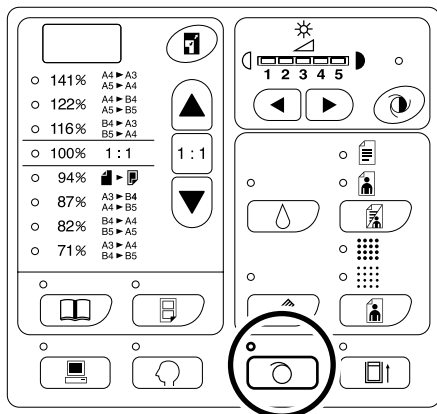

When the indicator is on, place an original, and then press the  key. After idling is executed, the master-making process is started.

Note:

- To clear the mode, press the  key again to turn off its indicator.
- Idling setting is not executed if the master-making operation is not performed.

Tip:

- **About Auto Idling Action**
(For RZ2XX, unavailable)

If the machine is not operated for a specified period of time, the indicator is automatically lighted and idling action is automatically executed when the next master-making operation is performed.

This function is called Auto Idling Action.

The Custom Setting mode allows you to change the initial setting for the above Auto Idling time.

 p.59

Advanced Features

Protecting Confidential Documents [Confidential Mode]

After printing is complete, the master remains on the Print Drum and is ready for printing another set of copies. To protect confidential documents from unauthorized duplication, use the Confidential feature to discard the master after printing.

1 Confirm that printing has ended.

Printing should be completely finished.

2 Press the  key to turn on its indicator.

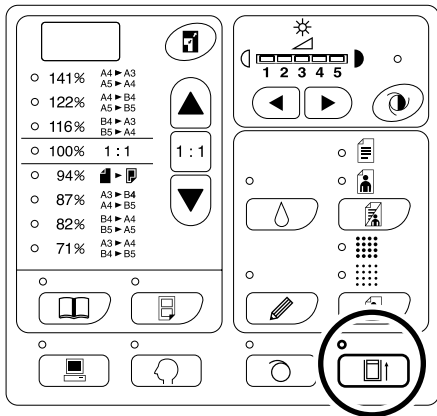

Note:

- To clear the mode, press the  key to turn off its indicator.

3 Press the  key.

The current master is discarded and replaced with a blank one.

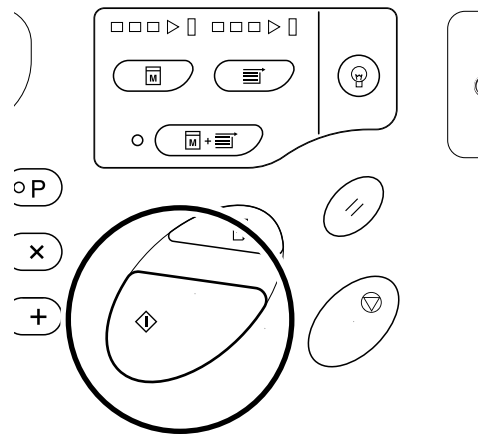

Note:

- After the discard and replacement, the Confidential mode is cleared.

Tip:

If you execute the Confidential mode processing when the  indicator is on, the machine operates confidential processing and idling action at the same time.

Printing with a Linked Printer (Option) (For RZ2XX, unavailable)

With optional Linked Printer connected, an original is scanned by the machine but printed out by the Linked Printer.

Important!:

- When connecting a Linked Printer, consult your dealer.
- Using a Linked Printer needs some settings to be made. [p.65](#)
- Only a single preset size of paper can be output from the tray of a Linked Printer. The Custom Setting mode allows you to change the initial setting for this paper size. (Initial setting: A4) [p.59](#)

1 Check that the Linked Printer has been correctly connected and that the power switches of the machine and the Linked Printer are ON.

2 Press the [***] key.**

The output destination is switched to the Linked Printer and "L" is displayed at the left end of the Print Quantity Display.

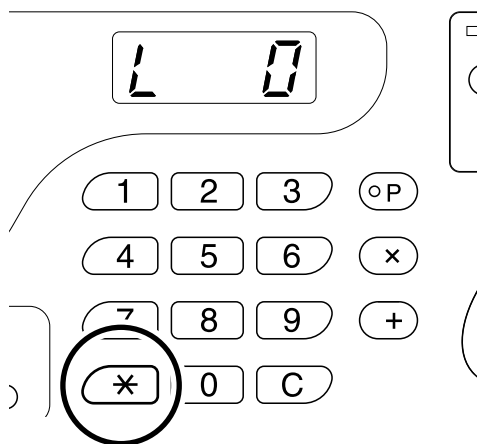

Note:

- To switch back to master-making and printing operations with the machine, press the [*****] key again.
- When you press the [*****] key immediately after the power switch is on, "L" may not appear on the display. In that case, please wait for a while. When "L" appears, move on to the next step.

3 Place an original.

• When placing on the Platen Glass

Open the Platen Cover and place the original face down. Align the centre of the original with the mark on the left-hand of the glass. After placing the original, slowly close the Platen Cover.

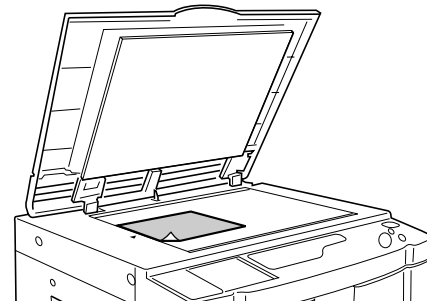

• When placing in the ADF unit (option)

Place originals face down, and then adjust the Original Guides to the width of the originals.

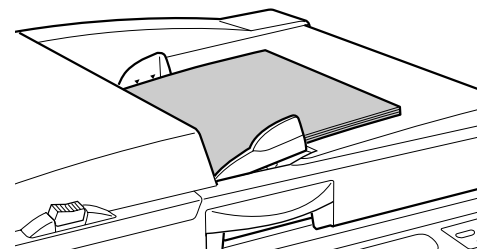

Note:

- You can place up to about 50 sheets of originals in the ADF unit.

Advanced Features

4 Make necessary settings.

You can set the following functions:

- Image Processing mode
- Pencil
- Enlargement/Reduction ratio
- Scanning level

5 Enter the number of copies to be printed, using the Print Quantity keys.

The specified number is shown on the Print Quantity Display.

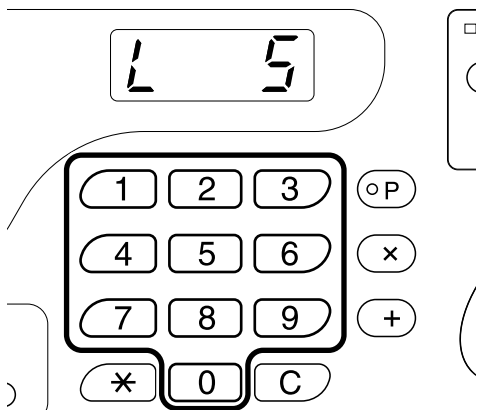

Note:

- If you enter an incorrect number, press the [C] key to clear the number, and then enter the correct number.

Important!:

- You cannot change the settings for the print speed, position, and density.

Note:

- If an error is shown on the Linked Printer, check if the preset size of paper differs from the paper size set on the Linked Printer. p.59
- If data is received from a computer while you are operating the machine, that data may be given a higher priority for making a master. To give a higher priority to printing with the Linked Printer, press the key to turn off its indicator.

Tip:

- Because of the Auto Switch function, you do not need to press the [*] key every time. If the number of copies to be printed is lower than a certain number, the Linked Printer is automatically selected for printing. If it is equal to or larger than the certain number, the machine is automatically selected for printing. The Custom Setting mode allows you to change the initial setting for this Link-free volume. (Initial setting: 20 copies) p.59
- Auto Switch function is not activated immediately after the power switch is on. Please wait for 15 to 60 seconds to move on to the next step. (It depends on the settings on Linked Printer.)

6 Press the key.

The original is scanned and the specified number of copies are printed by the Linked Printer.

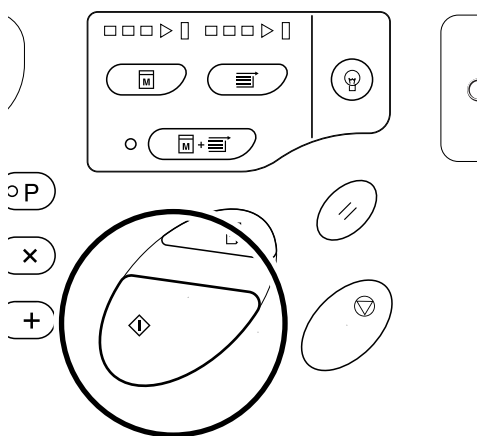

Customising the Initial Settings [Custom Setting Mode]

You can change the initial settings that are restored when the power is turned on or when the \swarrow key is pressed. Changed settings are effective until they are changed again.

The changeable items and their descriptions are as follows:

 :Initial setting (factory default)

Item No.	Changeable Items		Parameter Selection					
			0	1	2	3	4	5
01	Print speed Change the initial setting for the print speed.		1	2	<u>3</u>	4	5	
02	Print density (for RZ2XX, unavailable) Change the initial setting for the print density.		1	2	<u>3</u>	4	5	
03	Auto-Process Change the initial setting for the Auto-Process.		<u>OFF</u>	ON				
04	Scanning level Change the initial setting for the scanning level.	RZ3XX	1	2	3	4	5	<u>Auto</u>
		RZ2XX	1	2	<u>3</u>	4	5	
05	Image Processing mode Change the initial setting for the Image Processing mode. Important! • With the Photo mode or Duo mode selected, you cannot select "Auto" for the scanning level.		<u>Line</u>	Photo	Duo			
06	Size of originals for Book shadow editing Change the initial setting for the size of originals for Book shadow editing.	RZ3XX	<u>Paper</u>	A3	B4	A4	B5	
		RZ2XX	<u>Paper</u>	B4	A4	B5		
07	Width of central shadow for Book shadow editing Change the initial setting for the width of central shadow to be erased in the Book shadow editing.		<u>20mm</u>	30mm	40mm	50mm	80mm	
08	Auto idling time (for RZ2XX, unavailable) Change the initial setting for the auto idling time.		None	6 hours	<u>12 hours</u>			
09	2-Up printing interval time Change the initial setting for the 2-Up printing interval time.		None	<u>15 seconds</u>	30 seconds			

Advanced Features

Item No.	Changeable Items	Parameter Selection					
		0	1	2	3	4	5
10	<p>Energy Saving mode When the machine is not used for a certain period of time, it is automatically turned off or placed into the sleep status.</p> <ul style="list-style-type: none"> • OFF The machine remains on until its power switch is turned off. • Auto-Sleep The machine is usually off but switched on when data is received. • Auto-Power OFF The machine is switched off. <p>Note:</p> <ul style="list-style-type: none"> • It is recommended to select "Auto-Sleep" with a computer connected to the machine. 	OFF	<u>Auto-Sleep</u>	Auto-Power OFF			
11	<p>Energy Saving Mode wait time Select the waiting period required to lead the machine into the Energy Saving mode.</p>	<u>Approx. 5 minutes</u>	Approx. 15 minutes	Approx. 30 minutes	Approx. 60 minutes	Approx. 90 minutes	
12	<p>Auto clear time Select the waiting period required to make the machine automatically clear settings.</p>	<u>No</u>	Approx. 3 minutes	Approx. 5 minutes			
13	<p>Paper finish If paper is not supplied smoothly with "Standard" preset, you can use User 1 through 5 to programme the paper supply and output adjustment parameters suitable of paper to be used. For details, contact your dealer.</p> <p>Note:</p> <ul style="list-style-type: none"> • User 1 through 5 are not programmed when the machine is shipped. 	<u>Standard</u>	User 1	User 2	User 3	User 4	User 5
14	<p>Minimum print quantity Specify the minimum number of copies to be printed from one master. If a number lower than the specified minimum number is entered, the master-making process is not executed. You can lock and prevent this setting from being changed. For more information, consult your dealer.</p>	<u>0</u>	10 copies	20 copies	30 copies	40 copies	50 copies

Item No.	Changeable Items	Parameter Selection					
		0	1	2	3	4	5
15	<p>Beep sound Specify how an alarm should sound when keys are operated or errors occur.</p> <ul style="list-style-type: none"> Level 2 A beep sounds at all preset occasions; for example at the time of key operations and event generation/end. Level 1 A beep sounds only at the time of error occurrence, setting completion, pulling-out enabled, and 2-Up printing interval time. Level 0 A beep does not sound at any occasions. 	<u>Level 2</u>	Level 1	Level 0			
16	<p>Reservation Period Specify the time for restricting document data output from a computer when the machine is not operated.</p>	OFF	<u>15 seconds</u>	30 seconds	60 seconds		
17	<p>Semi-Auto(ADF unit) (available only with the optional ADF unit) With "ON" selected, if an original exists in the ADF unit after printing, the next master-making process is executed followed by proof copy, and then machine operation is stopped.</p> <p>Important!</p> <ul style="list-style-type: none"> With "ON" selected for Auto-Process, you cannot select "ON" for Semi-Auto. 	<u>OFF</u>	ON				
18	<p>Job Separation Select "ON" when using an Job Separator (option).</p>	<u>OFF</u>	ON				
19	<p>Tray paper size for a Linked Printer (for RZ2XX, unavailable) Change the initial setting for the paper size to be output from a Linked Printer (option).</p>	A3	B4	<u>A4</u>	B5		
20	<p>Print Quantity restoration setting Set the restoration setting for Print Quantity. Select "ON" when you want to restore the Print Quantity after printing is finished.</p>	<u>OFF</u>	ON				
21	<p>2-UP printing restoration setting Set the automatic restoration setting for 2-Up printing. Select "ON" when you want to restore the 2-Up printing after 2-Up printing is finished.</p>	<u>OFF</u>	ON				

Advanced Features

Item No.	Changeable Items	Parameter Selection					
		0	1	2	3	4	5
30	<p>Total Quantity Display</p> <p>The total number of copies printed with the machine is displayed. This number is displayed by two switching screens; a 3-digit number preceded by an under bar and a 4-digit number.</p> <p>Example: For 1,234,567 copies, _123→4567→_123→4567</p>	Execute steps 1 through 3 in "Changing Procedure". p.63 The total number of printed copies is shown on the Total Quantity Display.					
31	<p>Master Quantity Display</p> <p>The total number of masters generated with the machine is displayed. This number is displayed by two switching screens; a 3-digit number preceded by an under bar and a 4-digit number.</p> <p>Example: For 1,234,567 masters, _123→4567→_123→4567</p>	Execute steps 1 through 3 in "Changing Procedure". p.63 The total number of generated masters is shown on the Total Quantity Display.					
32	<p>Drum Print Quantity Display</p> <p>The number of copies printed with the current drum on the machine is displayed. This number is displayed by two switching screens; a 3-digit number preceded by an under bar and a 4-digit number.</p> <p>Example: For 1,234,567 copies, _123→4567→_123→4567</p>	Execute steps 1 through 3 in "Changing Procedure". p.63 The number of copies printed with the drum is shown on the Drum Print Quantity Display.					
70	<p>Base IP address setting (for RZ2XX, unavailable)</p> <p>Set an IP address for the machine.</p>	p.65					
71	<p>Link IP address setting (for RZ2XX, unavailable)</p> <p>Set an IP address for a Linked Printer (option).</p>	p.65					
72	<p>Link-free volume (for RZ2XX, unavailable)</p> <p>Set the threshold (number of copies) for automatically switching print output between the machine and a Linked Printer.</p>	p.67					
99	<p>Initial Setting Restoration</p> <p>Resets all Custom Setting mode settings to the initial settings (factory default).</p>						

Changing Procedure

- 1 Press the  key to turn on its indicator.**

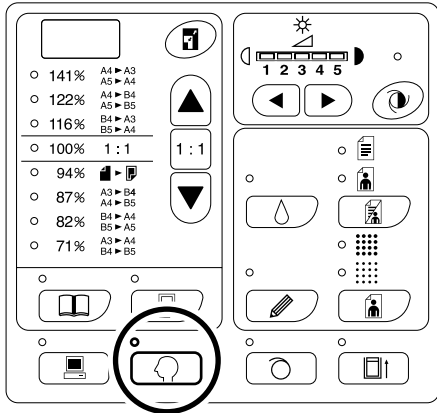

Note:



- To clear the mode, press the  key again to turn off its indicator.

- 2 Enter an item number to be changed, using the Print Quantity keys.**

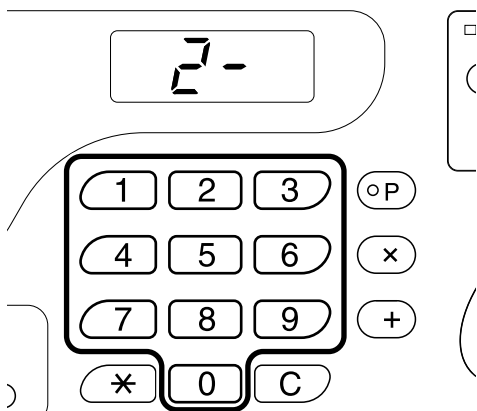
The Print Quantity Display shows the current parameter setting for the selected item number.



Note:

- For items No. 70 through 72, the operation procedures differ.
 - Item No.70 and 71:  p.65
 - Item No.72:  p.67
- To restore the initial settings for the Custom Setting mode, enter "99" and press the **[+]** key, and then press the  key.

- 3 Press the **[+]** key.**

Pressing this key allows you to select a parameter number.

The currently set parameter number blinks.

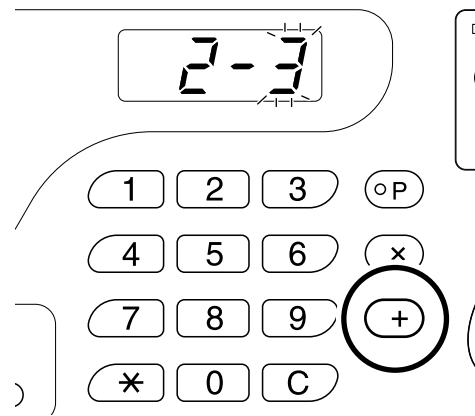

- 4 Enter a parameter number using the Print Quantity keys.**

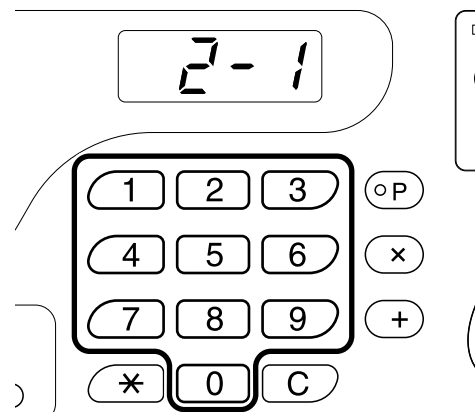

If there are more than one item to be changed, press the **[+]** key, and then repeat steps 2 through 4.

Advanced Features

5 Press the key to complete the settings.

The changed contents are programmed and the normal mode is restored.

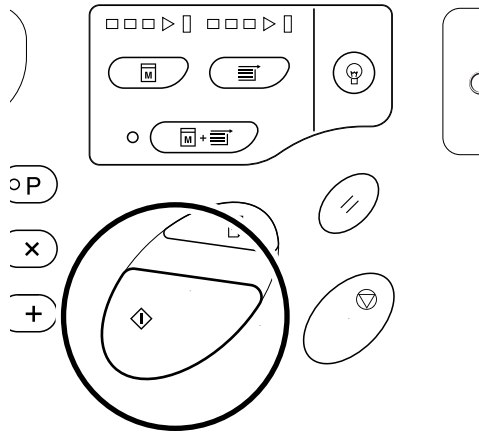

IP Address Setting (for RZ2XX, unavailable)

When connecting a Linked Printer (option) or a computer, you need to set IP addresses on the machine and the Linked Printer.

1 Press the  key to turn on its indicator.

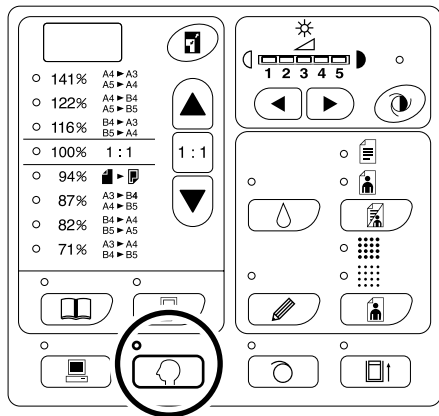

Note:

- To clear the operation, press the  key again to turn off its indicator.

2 Enter an item number using the Print Quantity keys.

The item numbers are as follows :
 IP address for the machine : 70
 IP address for the Linked Printer : 71

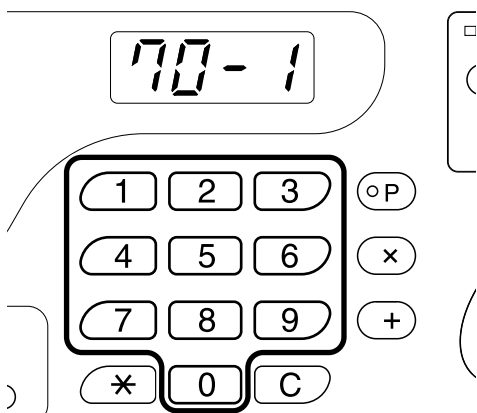

3 Enter the first field using the Print Quantity keys.

The entered number is shown on the Free Reproduction Size Display.

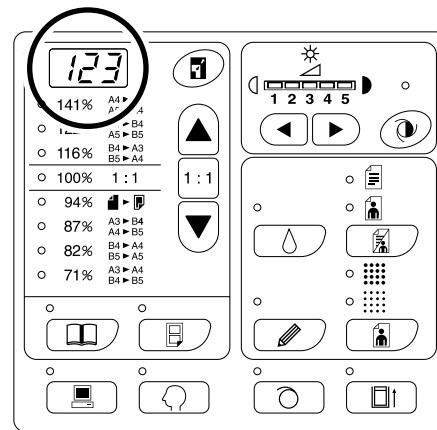

Note:

- The IP address numbers separated by dots are called the first field, second field, and so on in the order.
- The initial IP address settings for the machine and a Linked Printer are "0.0.0.0".

4 Press the [+] key.

Continue to the next field. The Print Quantity Display changes.

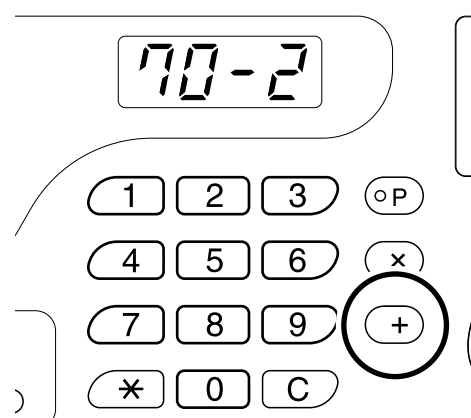

Advanced Features

5 Repeat steps 3 and 4 to enter an IP address up to the fourth field.

6 Press the  key.

The IP address setting is completed.

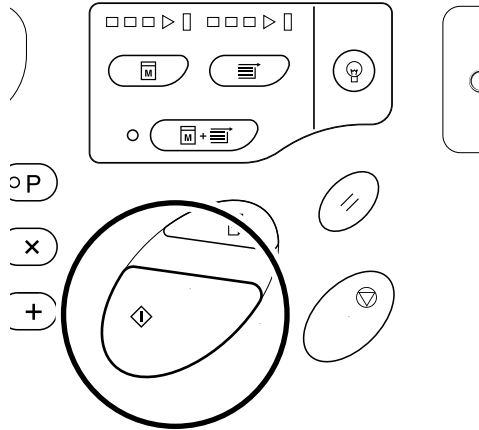

Setting the Link-free volume (for RZ2XX, unavailable)

When entered print quantity is smaller than the specified Link-free volume (number of copies), a Linked Printer is automatically selected for printing. If entered print quantity is equal to or larger than the Link-free volume, the machine is selected for printing.

- 1** Press the  key to turn on its indicator.

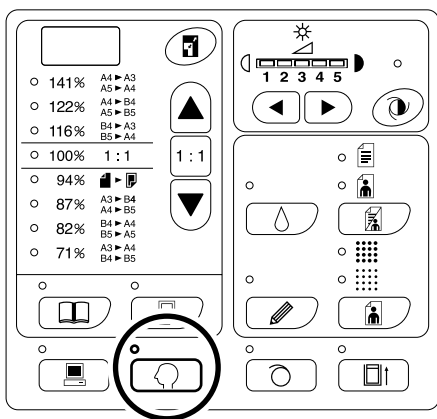

Note:

- To clear the mode, press the  key to turn off its indicator.

- 2** Enter "72" using the Print Quantity keys.

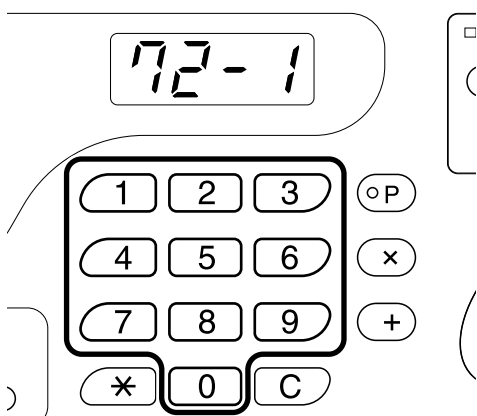

- 3** Enter a Link-free volume number using the Print Quantity keys.

The entered number is shown on the Free Reproduction Size Display.

The selectable range is 0 through 99.

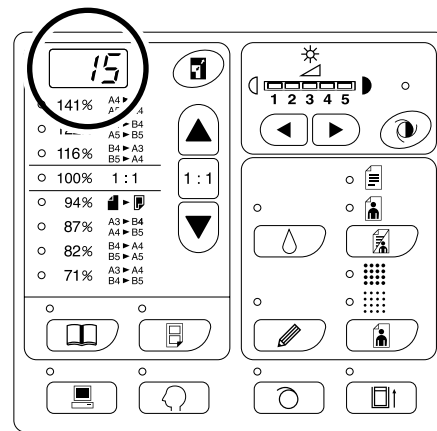

Note:

- If you enter an incorrect number, press the [C] key, and then enter the correct number.
- The initial setting is "20 copies".

- 4** Press the  key.

The Link-free volume setting is completed.

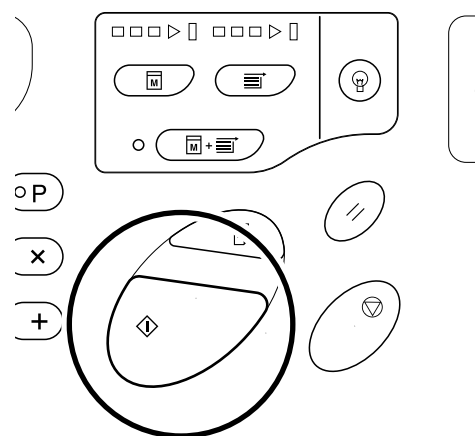

Replacing and Disposing Consumables

Replacing the Ink Cartridge

When the Ink Cartridge becomes empty, the Ink Replacement indicator lights. Replace with a new Ink Cartridge.

Important!:

- For the Ink Cartridge, it is recommended to use the products specified by RISO.
- Before replacing the Ink Cartridge, turn the machine on.
- Make sure to use the Ink Cartridge of the same colour ink. If you want to change the ink colour, replace the Print Drum itself.

1 Open the Front Cover.

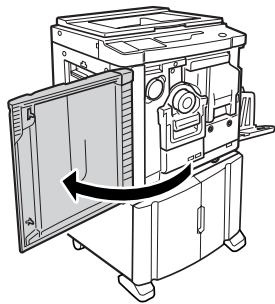

2 Pull the empty Ink Cartridge out of the holder.

Turn the Ink Cartridge counterclockwise (🔓), and then pull it out.

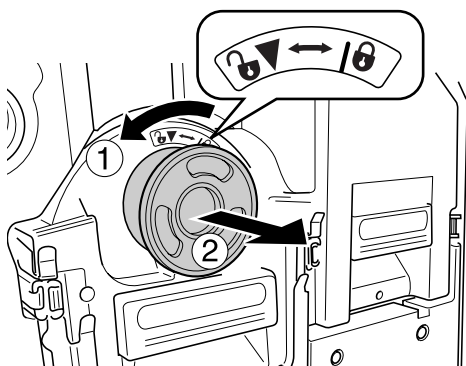

3 Remove the cap from a new Ink Cartridge.

Turn the cap of the Ink Cartridge to remove the cap.

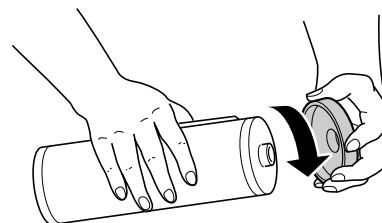

Important!:

- Do not touch or give impact to the outlet surface of the new Ink Cartridge.

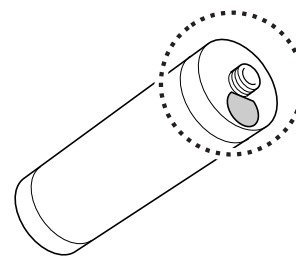

4 Insert the new Ink Cartridge.

Align the arrow on the Ink Cartridge with the ▼ mark on the holder, and push the Ink Cartridge until it stops.

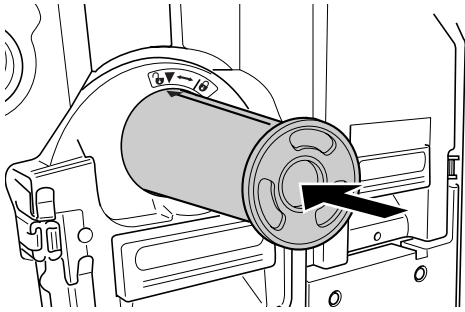

5 Lock the Ink Cartridge.

Turn the Ink Cartridge clockwise (🔒) to lock it.

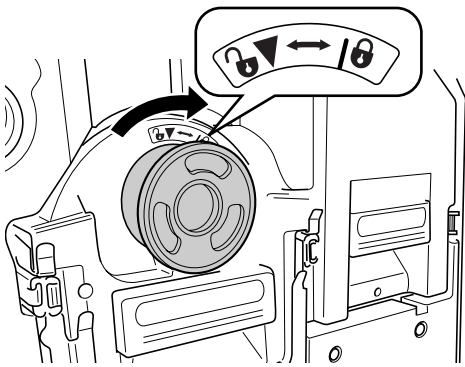

🔒:Lock

6 Close the Front Cover.

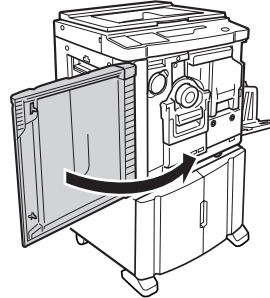

Note:

- You can use the Ink Cartridge Cap Holder to keep the cap.

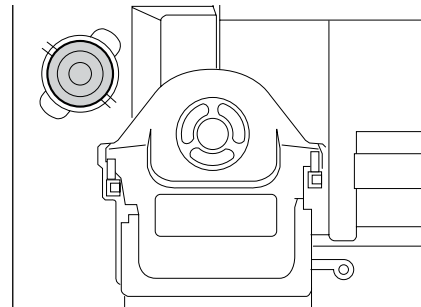

- Dispose the empty Ink Cartridge according to the disposal rule of your local community. p.74

Replacing and Disposing Consumables

Replacing the Master Roll

When the entire Master Roll is consumed, the Master Replacement indicator lights. Replace with a new Master Roll.

Important!:

- For the Master Roll, it is recommended to use the products specified by RISO.

1 Open the Front Cover.

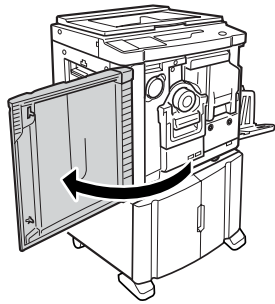

2 Check the indicator of the Master Making Unit Release button is on.

If the indicator is off, press the Master Making Unit Release button to turn on its indicator.

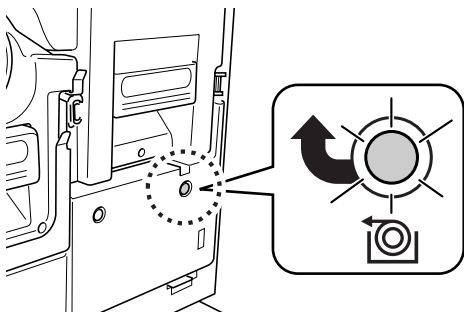

 : Master Making Unit Release button

Note:

- With the Print Drum pulled out, you cannot pull out the Master Making Unit. Place the Print Drum into position, and then press the Master Making Unit Release button.
☞ p.75

3 Pull out the Master Making Unit.

Grasp the Master Making Unit Handle and pull out the Master Making Unit until it stops.

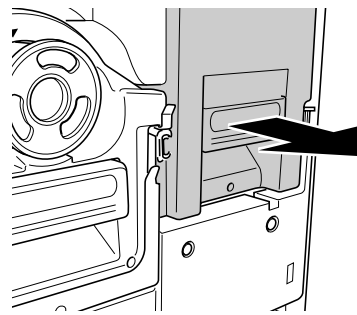

4 Open the Master Making Unit Cover.

Grasp the Master Making Unit Cover Lever and open the Master Making Unit Cover.

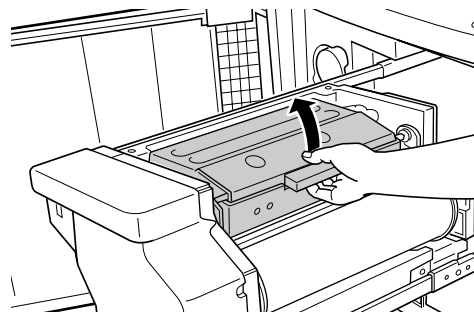

5 Open the Master Roll Holder.

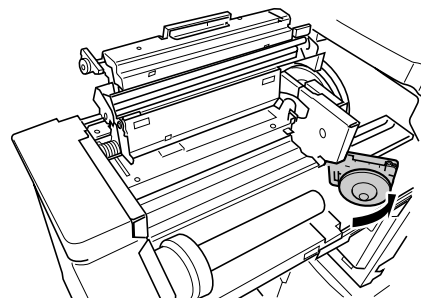

6 Remove the depleted Master Roll.

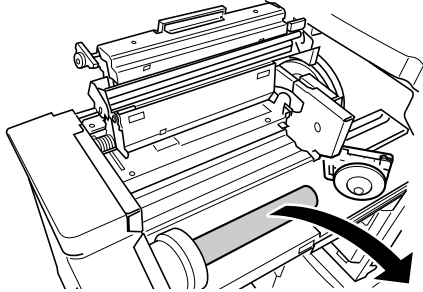

Note:

- Dispose the depleted Master Roll according to the disposal rule of your local community. [p.74](#)

7 Install a new Master Roll.

Remove the shrink package (transparent film) from the new Master Roll, and place the roll so that the **i** mark on the master core comes to the left.

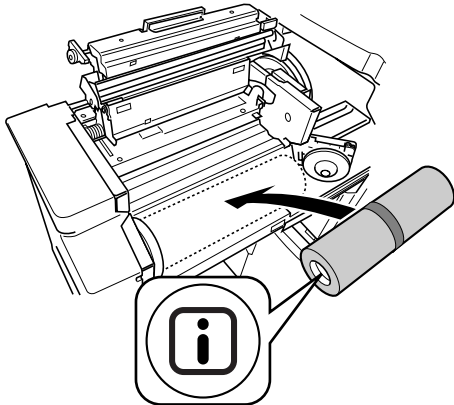

Important!:

- When removing the shrink package, be careful not to damage the section having the **i** mark. If that section is bent or the perforated line is cut, the master roll becomes unavailable.

8 Close the Master Roll Holder.

After closing the Master Roll Holder, remove the wrapper.

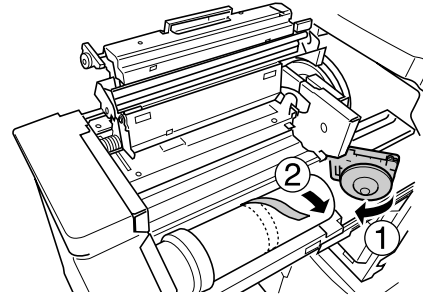

9 Insert the leading edge of the Master Roll into its entrance under the Master Guide Flap.

Insert the leading edge until it stops (①). If the master is loose, turn the flange at the right inward to rewind (②).

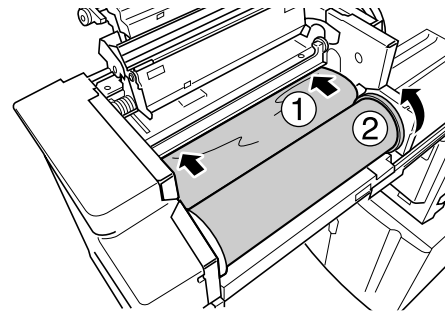

Replacing and Disposing Consumables

Tip:

- If you cannot insert the leading edge of the master well, use the following procedure:

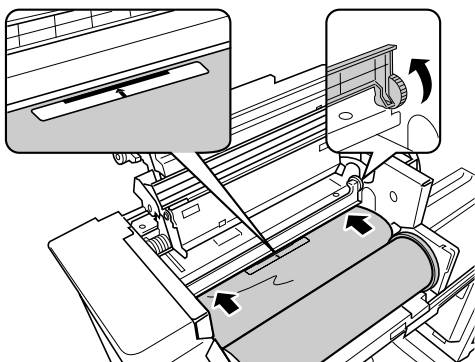

- 1) **Raise the Master Guide Flap.**
Turn the wheel beside the Master Guide Flap inward to raise the Master Guide Flap.
- 2) **Pull out the Master Roll up to the line indicated by the arrows.**
- 3) **Lower the Master Guide Flap to the original position.**

10 Return the units to the original positions.

Close the Master Making Unit Cover, return the Master Making Unit to the original position, and then close the Front Cover.

Emptying the Master Disposal Box

1 Pull out the Master Disposal Box.

Grasp the handle of the Master Disposal Box and pull out the box to the left.

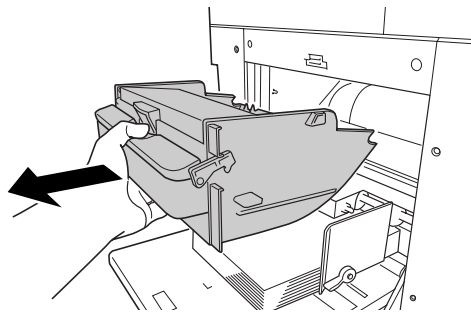

3 Place the Master Disposal Box into position.

Insert the Master Disposal Box until it stops.

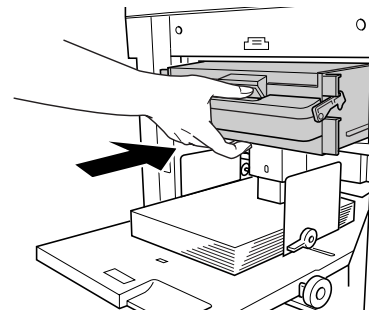

2 Discard the ejected masters.

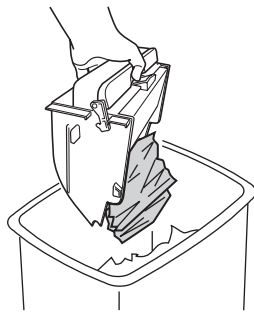

Note:

- Dispose the ejected masters according to the disposal rule of your local community. p.74

Note:

- If masters adhere to the inside of the Master Disposal Box, press the lever located on the handle.

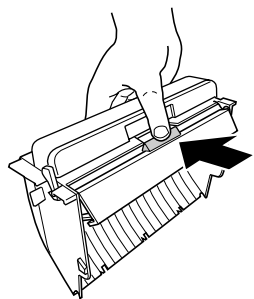

Replacing and Disposing Consumables

Disposal of Depleted Consumables

Dispose the depleted Ink Cartridges, Master Rolls and ejected masters according to the regulations in your local community.

If required, separate the specific components using the following procedures to dispose them properly.

Ink Cartridge

Remove the label (metal included) at the arrow from the outlet surface of the Ink Cartridge, and then dispose them separately.

Because ink may have adhered to the outlet surface of the Ink Cartridge, be careful not to dirt your clothes.

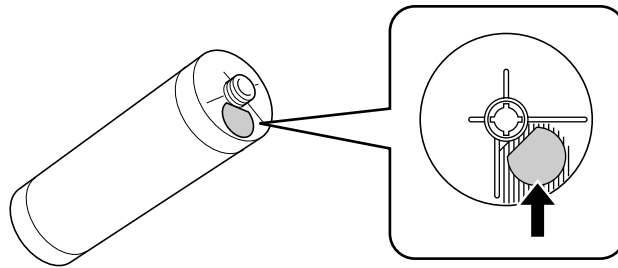

Ink Cartridge material: plastic (polypropylene, polyethylene)

Label material: plastic (metal included)

Master Roll

A metallic component has been attached to the bottom of the end section having the **i** mark stamped. Because the component section has been perforated for cutout convenience, tear along the perforation for proper disposal.

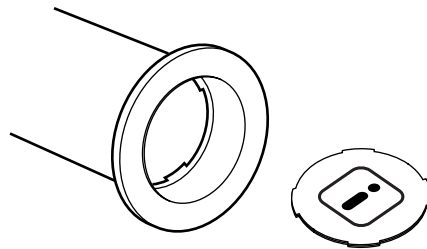

Core material: paper

Master material: plastic, Japanese paper

Material of the cut out component: plastic (metal included) and paper

Ejected Master

Master material: plastic, Japanese paper

Ink material: petroleum hydrocarbon, water, pigment

Removing and Installing the Print Drum

When replacing with a colour drum or dealing with paper jams, remove the Print Drum, take a necessary procedure, and then install the drum.

Important!:

- Make sure to place and keep the removed Print Drum horizontal.
- Make sure to place the replaced Print Drum in the drum case and keep it horizontal.

1 Open the Front Cover.

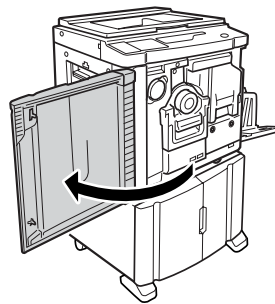

2 Check that the indicator of the Print Drum Release button is on.

If the indicator is off, press the Print Drum Release button to turn on its indicator.

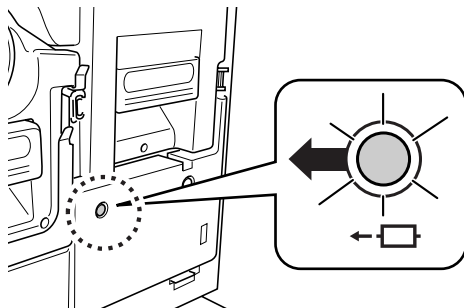

← □ : Print Drum Release button

Note:

- With the Master Making Unit pulled out, you cannot remove the Print Drum. Place the Master Making Unit into position, and then press the Print Drum Release button. [p.70](#)

3 Pull out the Print Drum.

Grasp the Print Drum Handle and pull out the Print Drum until it stops.

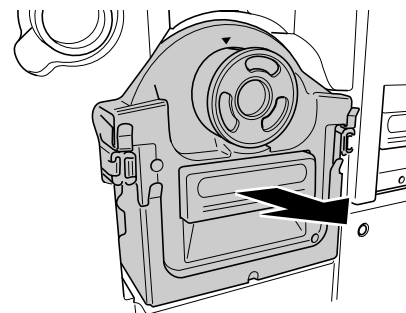

4 Remove the Print Drum.

Lift the Print Drum with both hands to remove it from the guide.

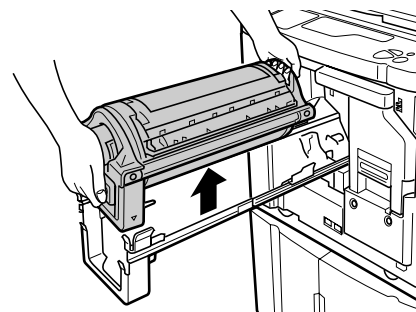

⚠ Caution:

- Do not touch the connector on the Print Drum. Neglecting this may result in malfunction of the Print Drum because of static electricity or other factors.

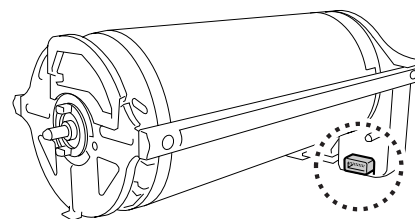

Replacing and Disposing Consumables

5 Install the Print Drum.

Align the ▼ mark with the ▲ mark on the guide and position the Print Drum horizontal relative to the guide.

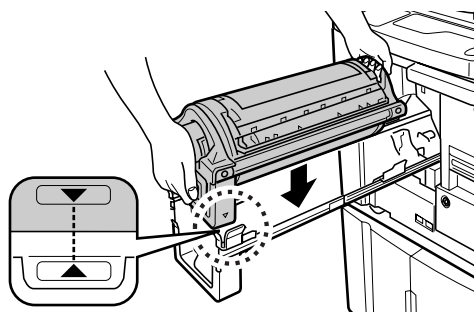

Note:

- If you manually rotate the Print Drum, make sure to rotate it so that the ► and ◄ marks meet shown as below after the installation.

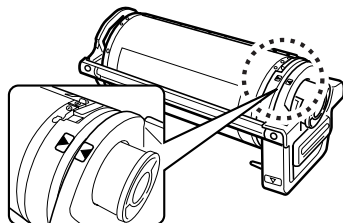

6 Return the units to the original positions.

Place the Print Drum into position, and then close the Front Cover.

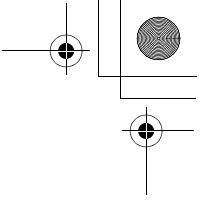
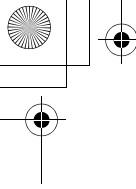

Replacing and Disposing Consumables

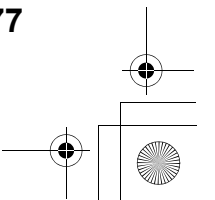
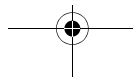
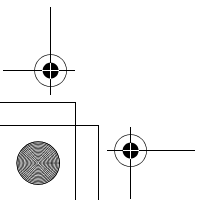
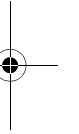
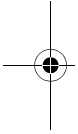

Cleaning

Safety Guide - Cleaning

This section describes the precautions to be observed when cleaning the machine.
Read this section before cleaning the machine.

▲WARNING:

- Before cleaning any part of the machine, turn off the power.
- Do not remove any fixed covers.
- Contact your service representative immediately if you suspect any dangerous situations or have questions or problems with the machine.
- Contact your service representative before moving the machine.
- Do not allow unauthorised persons to make adjustments or repairs.

▲Caution:

- The machine has precision moving parts inside. Do not handle the machine in any other way than described in this guide.
- Be careful of the edge of metal parts, otherwise it may cause an injury.
- Do not make any modifications to the machine or remove any parts.
- Neither RISO nor its dealer is responsible for maintenance service performed by non-RISO-authorized personnel.

Cleaning

Thermal Print Head

Clean the Thermal Print Head each time you replace the Master Roll. Open the Master Making Unit Cover, and then gently wipe the Thermal Print Head in the back of the unit several times with a soft cloth or tissue.

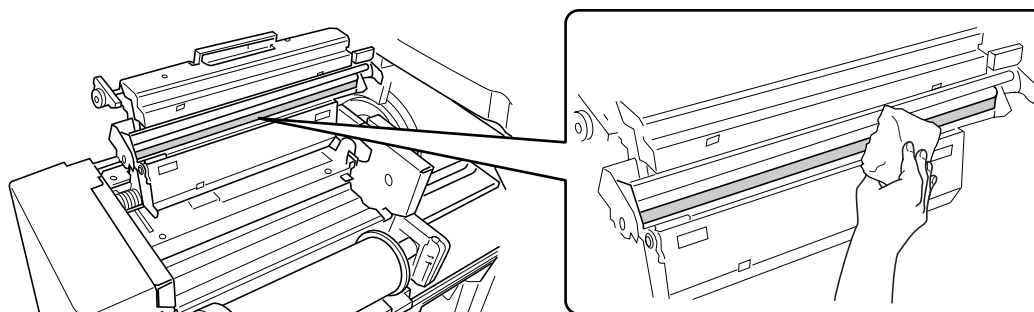

⚠ Caution:

- Since the Thermal Print Head is very delicate, avoid shocks or scratches with a hard object.
- Since Thermal Print Head is susceptible to (damage by) static electricity, please be sure to remove the static electricity charged in the body before cleaning.

Note:

- For more effective cleaning, dampen a soft cloth or tissue with a small amount of alcohol before wiping the Thermal Print Head.

Platen Glass and Platen Cover

If the Platen Glass and/or Platen Cover is stained, gently wipe them with a soft cloth or tissue.

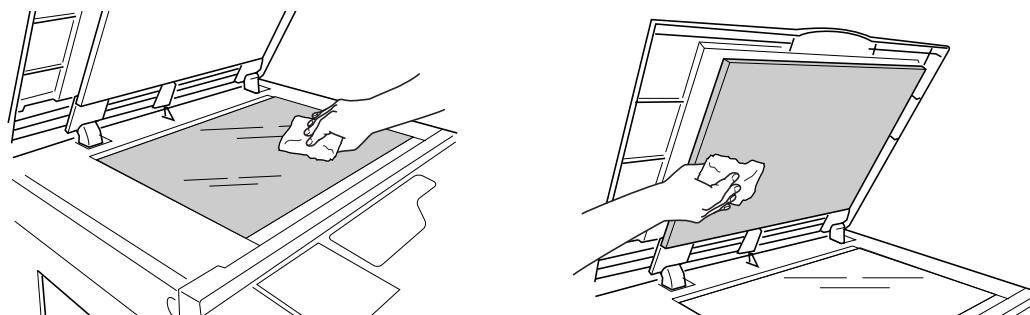

⚠ Caution:

- Since the Platen Glass is very delicate, avoid shocks or scratches with a hard object.

Cleaning

Pressure Roller

If the Pressure Roller, which presses print paper against the Print Drum, is stained, smudged strips may appear on the back of copies.

If this happens, gently wipe the Pressure Roller with a soft cloth dampened with alcohol.

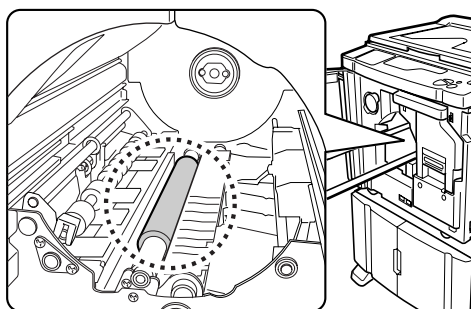

⚠ Caution:

- When putting your hand into the unit, do not touch the paper separation hook. The sharp tip of the hook can hurt your hand.

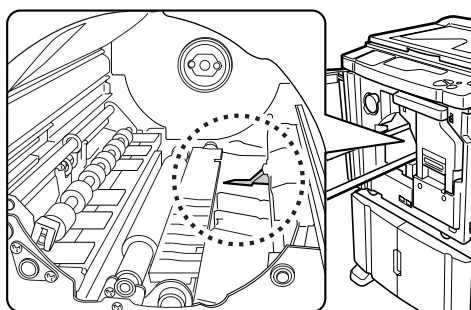

Printer Exterior

In order to protect the machine from dust, wipe the machine exterior periodically with a soft cloth. If using cleanser, use an appropriate one recommended by your authorized service representative.

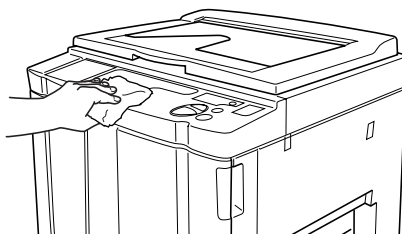

⚠ Caution:

- Because the machine exterior is plastic, never use alcohol or solvent when cleaning.

Scanner Glass and White Sheet of the ADF unit (Option)

Gently wipe the Scanner Glass (for RZ2XX, unavailable), and the White Sheet several times with a soft cloth or tissue.

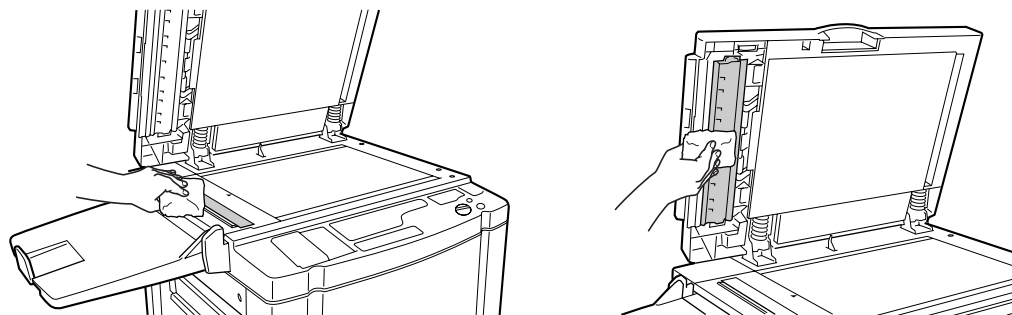

⚠ Caution:

- Since the Platen Glass is very delicate, avoid shocks or scratches with a hard object.

Note:

- For more effective cleaning, dampen a soft cloth or tissue with a small amount of alcohol before wiping the Scanner Glass and White Sheet.

Troubleshooting

Check & Error Display

When an error occurs on the machine or when consumables or other sections are not yet ready, the Check & Error Display shows error locations and numbers indicating error types. For some errors, error numbers are shown on the Error Number Display (Print Quantity Display).

Checking with the Check & Error Display

Besides indicators that show error types, numbers that show error locations light. Check the display and take an appropriate procedure according to the methods described on the subsequent pages.

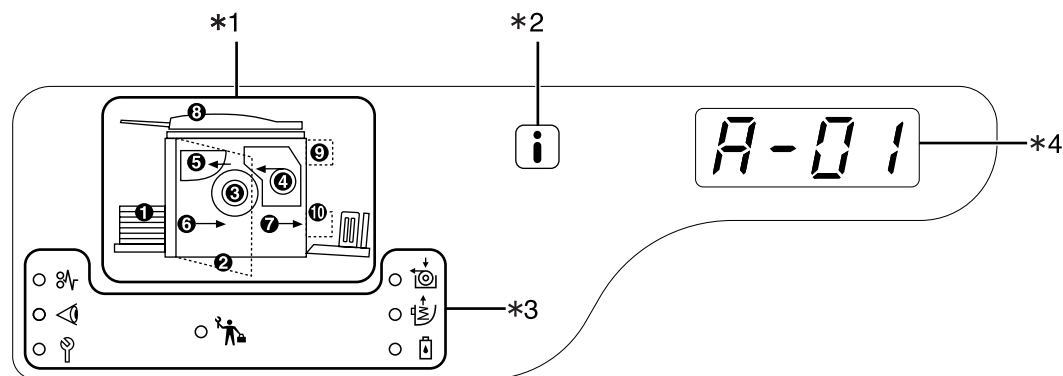

- 1) **Error Location Indicator [*1]**
Numbers corresponding to error locations light.
- 2) **i indicator [*2]**
Lights when the function is in use.
p.90
- 3) **Error Type Indicator [*3]**
 - **⌘ (Jam) Indicator**
Lights when paper jams occur inside the machine or ADF unit (option).
 - **◀ (Check Settings) Indicator**
Lights when the Print Drum, paper, or other items have not yet set up.
 - **🔧 (Call Service) Indicator**
Lights when such an error occurs that needs advices or supports from service personnel.
 - **👤 (Maintenance Call) Indicator**
Lights when the time for periodic inspection comes.
 - **🔄 (Replace Master Roll) Indicator**
Blinks when the remaining master quantity is small and lights up when the entire master is consumed.
 - **🗑️ (Empty Disposal Box) Indicator**
Lights when the Master Disposal Box is full.
 - **🖨️ (Replace Ink Cartridge) Indicator**
Blinks when the remaining ink quantity is small and lights up when the entire ink is consumed.
- 4) **Error Number Display (Print Quantity Display) [*4]**
Error numbers appear and blinks on the Print Quantity Display.
Error contents are shown with alphabetical characters (single digit) and numeric characters (two digits).

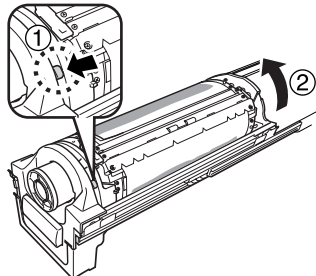
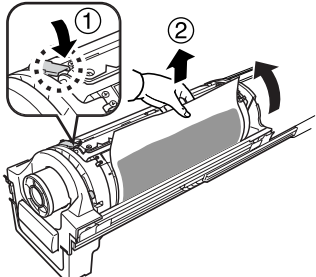

When the V indicator [Area *3] blinks

Check error locations and error numbers (Error Number Display) and take the following procedures:

Location No.	Error No.	Cause	Action
①	A-06	Any obstacle exists under the Paper Feed Tray or on paper.	Check if any obstacle exists under the Paper Feed Tray or on paper. If an obstacle exists, remove it.
③	A-02	A master has not been correctly wrapped around the Print Drum.	<ol style="list-style-type: none"> 1) Pull out the Print Drum. <small>☞ p.75</small> 2) Press the Print Drum Release Lever (①), hold the edge of the Print Drum, and turn the Drum until the clamp plate (metallic plate locking the master) comes to the top (②).  <ol style="list-style-type: none"> 3) Press the Clamp Plate Release Lever (①) to unlock the clamp plate, hold the edge of the master, and then separate the master while turning the Print Drum (②).  <ol style="list-style-type: none"> 4) Turn the Print Drum until the ▲ marks meet. 5) Set the Print Drum into the machine. 6) Pull out the Master Making Unit and set the master again. 7) Place the Master Making Unit into position. 8) Perform the master-making operation again.

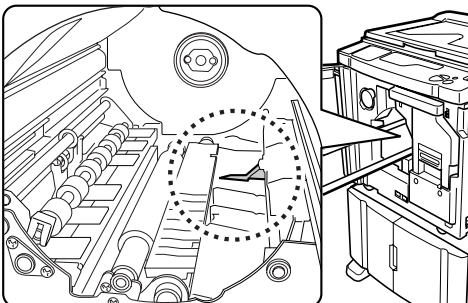
Troubleshooting

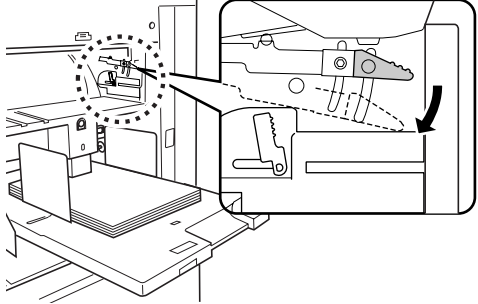
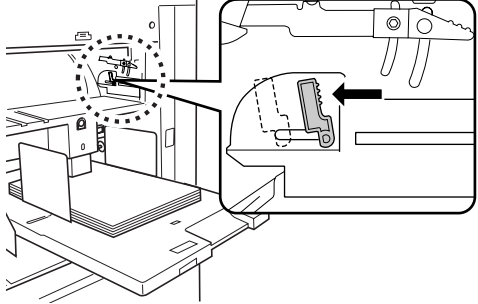
Location No.	Error No.	Cause	Action
3	A-02	A master has not been correctly wrapped around the Print Drum.	<p>⚠ Caution:</p> <ul style="list-style-type: none"> The Print Drum is equipped with many metallic components. Touch the Print Drum only when necessary. These components may cut your fingers. When turning the Print Drum with hand, do not grab the handle on the rear side of the Print Drum. Be careful that your fingers will not be caught and hurt. When turning the Print Drum with hand, hold the edge of the Print Drum. If you push on the master, your fingers may be smudged with ink. The Clamp Plate opens while the Clamp Plate Release Lever is pressed. Be careful that your fingers will not be caught and hurt. The seperated master is covered with ink. Be careful that the master will not contact with other objects.
	A-04	A master has not been sent to the Master Disposal Box.	<ol style="list-style-type: none"> 1) Pull out the Print Drum and remove the master on the drum. ☞ p.75 2) Set the Print Drum again. 3) Press the  key.
	A-16	An unnecessary master remains on the Print Drum.	<ol style="list-style-type: none"> 1) Perform actions 1) through 5) provided for error No. "A-02". ☞ p.83 2) Perform the master-making operation again.
	J-04	A paper jam has occurred around the Print Drum.	<ol style="list-style-type: none"> 1) Pull out the Print Drum. ☞ p.75 2) If you find jammed paper, remove it. <p>⚠ Caution:</p> <ul style="list-style-type: none"> When putting your hand into the machine to remove paper, do not touch the paper separation hook. The sharp tip of the hook may hurt your hand. 



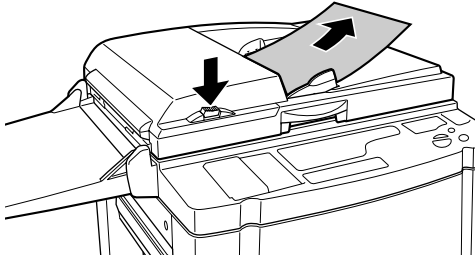
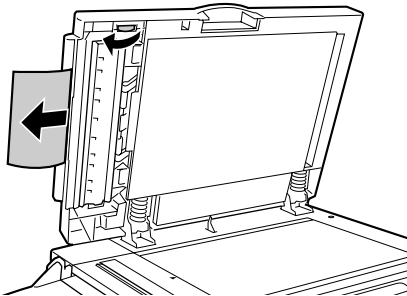

Location No.	Error No.	Cause	Action
4	A-01 A-34	A master has not been correctly set.	Open the Master Making Unit Cover, remove the master roll, and set the master correctly. If the master is loose, turn the right flange inward to correct it, and close the Master Making Unit Cover. ☞ p.70
	A-17	A master has not been correctly cut.	1) Remove the master roll and close the Master Making Unit Cover. 2) Set the master again. ☞ p.70
5	A-05	A master jam has occurred in the master disposal section.	<p>1) Remove the Master Disposal Box. 2) Stand at the side of the Paper Feed Tray and push down the Master Disposal Roller Release Lever at the inside right.</p>  <p>3) Remove the master jammed on the roller section. 4) Push the Master Disposal Roller Lock Lever inward.</p>  <p>5) Set the Master Disposal Box. ☞ p.73</p>
6	J-08	A paper jam has occurred on the Paper Feed Tray section.	<p>1) Remove the jammed paper. 2) Set paper again. 3) If the error indications do not disappear, press the  key.</p>

Troubleshooting

Location No.	Error No.	Cause	Action
7	J-02	A paper jam has occurred on the Paper Receiving Tray section.	Remove the paper jammed on the Paper Receiving Tray section. If the error indications do not disappear, press the // key.
8	J-01	A paper jam has occurred in the ADF unit (option).	<p>Remove the original jammed in the ADF unit.</p> <ul style="list-style-type: none"> When removing in the document insertion direction With the ADF Original Release Button pressed, pull out the original.  <ul style="list-style-type: none"> When removing in the document output direction After opening the Platen Cover, pull out the original while turning the ADF Original Release Dial. 



When the indicator [Area *3] blinks

Check error locations and error numbers (Error Number Display) and take the following procedures.
If an error number is not shown, press the [] key.

Location No.	Error No.	Cause	Action
①	c-04	The tray has run out of paper.	Place paper on the Paper Feed Tray.
	F-03	Custom-size paper has been placed on the Paper Feed Tray at the time of 2-Up printing.	Custom-size paper does not allow 2-Up printing. Press the  key and then place regular-sized paper.
②	d-11	The Front Cover is open or has not been completely closed.	Close the Front Cover completely.
③	d-01	The Print Drum has not been set or has not been correctly set.	Set the Print Drum correctly.  p.75
	d-02	An inappropriate Print Drum has been set.	Set an appropriate Print Drum.  p.75 Important! • Use a Print Drum specific to the machine. Set other drums can result in malfunction or any other troubles.
	d-03	The Ink Cartridge has not been set or has not been correctly set.	Set an Ink Cartridge correctly.  p.68
	d-04	An inappropriate Ink Cartridge has been set.	Set an Ink Cartridge specific to the machine.  p.68 Important! • Use an Ink Cartridge specific to the machine. Using other Ink Cartridges can result in malfunction or any other troubles.
The label on the Ink Cartridge outlet surface has come off or surface is with dirt.		The label on the Ink Cartridge outlet surface contains information needed for printing. If the machine cannot read the information, it does not operate. Set an Ink Cartridge that is specific to the machine and that is with label attachment and free from dirt.	

Troubleshooting

Location No.	Error No.	Cause	Action
③	F-01	A master has not been wrapped around the Print Drum.	Place an original and start with the master-making process. If you leave the machine without a master wrapped around the Print Drum, malfunction may occur. Press the // key, and then press the []↑ key. Or perform master-making operation to wrap a master around the drum.
	F-02	The master currently wrapped around the Print Drum for print size is larger than paper placed on the Paper Feed Tray.	Press the // key, and then replace with paper in larger size. If you start to print without paper replacement, the part outside the paper size smudges the Pressure Roller. If you want to start printing regardless of this problem, press the ◊ key or the [] key. To stop printing, press the // key.
④	d-05	A master roll has not been set or has not been correctly set.	Set a master roll correctly and close the Master Making Unit Cover. ☞ p.70 If a rewound master has been wrinkled or has worn off, cut the edge of the master straight and then set the master again.
	d-08	The Master Making Unit has not been correctly set.	Set the Master Making Unit correctly. ☞ p.70
	d-09	The Master Making Unit Cover has not been closed.	Pull out the Master Making Unit and close the Master Making Unit Cover completely. ☞ p.70
	d-17	An inappropriate master roll has been set.	Set a master roll specific to the machine.
The [i] section on the master core is missing, or it has worn off, or it has been tilted.		The [i] section on the master core contains information needed for making masters. If the machine cannot read the information, it does not operate. Set a dedicated Master Roll that has the [i] mark and is free from wear and tilt.	
⑤	d-07	The Master Disposal Box has not been set or has not been correctly set.	Set the Master Disposal Box correctly. ☞ p.73
⑧	F-37	Originals have been placed in the ADF unit (option) in the Book shadow editing.	Press the // key and then place an original on the Platen Glass. Or quit the Book shadow editing. ☞ p.38
⑨	b-01	A card has not been set to the Key Card Counter (option).	Set a card to the Key Card Counter.

Location No.	Error No.	Cause	Action
⑩	b-22	Power to the Job Separator (option) is off.	Turn on the power to the Job Separator.
	b-23	The Job Separator (option) has run out of tape.	Set new tape to the Job Separator.
	b-24	A tape jam has occurred in the Job Separator (option).	Check the Job Separator and remove the jammed tape.
Non	b-31	Data send to the Linked Printer (option) has failed.	<ul style="list-style-type: none"> • Check that the cables of the Linked Printer and the machine have been correctly connected to the hub, for example. • If the cable connections are appropriate, check the communication status of the server and/or network. • Check with the manager of the server or network.
	b-32	Power to the Linked Printer (option) is off. Another possible cause is an inappropriate cable connection or cable line disconnection.	<ul style="list-style-type: none"> • Check that the Linked Printer has been switched on. • Connect the cables correctly.
	b-33	An IP address has not been set for the machine.	Using the Custom Setting mode, set the IP address for the machine. ☞ p.65
	F-05	An attempt is being made to print a smaller number of copies than the minimum print quantity.	Select a larger number of copies than the minimum print quantity. ☞ p.59
	F-58	Because the RISORINC-NET has been initiated, the Linked Printer (option) cannot be used for output.	<ul style="list-style-type: none"> • To output from the machine Press the  key, and then press the  key. • To output from the Linked Printer. Press the  key, wait for a while, and then try again.

When the indicator [Area *3] lights

Because the entire master roll has been consumed, set a new master roll.
☞ p.70

When the indicator [Area *3] lights

Because the Master Disposal Box is full, remove the box and discard the ejected masters.
☞ p.73

When the indicator [Area *3] lights

Because the Ink Cartridge becomes empty, replace with a new Ink Cartridge.
☞ p.68

When the indicator [Area *3] lights

Check error numbers shown on the Error Number Display and contact your dealer.

When the indicator [Area *3] lights

Contact your dealer and take a periodic inspection.

Troubleshooting



When the  indicator [*2] is off and “H” is shown on the Print Quantity Display [*4].

In order to assure optimum printing, the machine acquires information from the consumables.
 If acquired matching information is not proper, “H” is shown on the Print Quantity Display.
 Enter an appropriate parameter.
 Entering an inappropriate parameter does not affect usual operations but may result in bad print quality.
 The table shows the “H” numbers to be shown on the Print Quantity Display and the selectable parameters.

Location No.	H No.	Description	Parameter
③	H1	Ink colour setting Select the same colour as the currently used for Print Drum.	1: black 2: colour
	<u>H2</u>	Print density fine adjustment (ink) Perform fine adjustment to optimize the print density depending on the ink.	1 (light) - 5 (dark)
	<u>H3</u>	Sample copy density adjustment (ink) Perform adjustment for print density for test printing depending on the ink. This adjustment is independent of H2.	1 (light) - 5 (dark)
④	H4	Master-making density setting Set the reference density for the master-making process.	1 (light) - 10 (dark)
	<u>H5</u>	Print density fine adjustment (master) Perform fine adjustment to optimize the print density depending on the master.	1 (light) - 5 (dark)
	<u>H6</u>	Sample copy density adjustment (master) Perform adjustment for the print density for sample copy depending on the master. This adjustment is independent of H5.	1 (light) - 5 (dark)

— : For RZ2XX, unavailable

Note:

- When you perform the following operations, entered H No's information disappears and thus you need to enter H No's again.
 - After the power switch is set to  (OFF), the switch is set to  (ON) again
 - After the machine is placed into the Sleep status, the  key is pressed
- If you are not sure the best setting for the supply(s) used in the machine, we may suggest you start from 1(default setting) except for H1 indication and adjust if necessary based on the result of print.
 Riso takes no responsibility, and cannot advise as to the best setting, for particular supplies not manufactured and sold by Riso.

Use the following procedure to enter necessary information.

1 Enter a parameter using the Print Quantity keys.

The parameters that can be entered differ among the consumables.

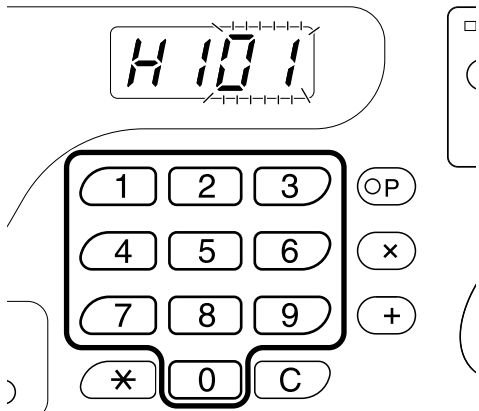

2 Press the \diamond key to complete the setting.

If the next H No. appears, repeat steps 1 and 2.

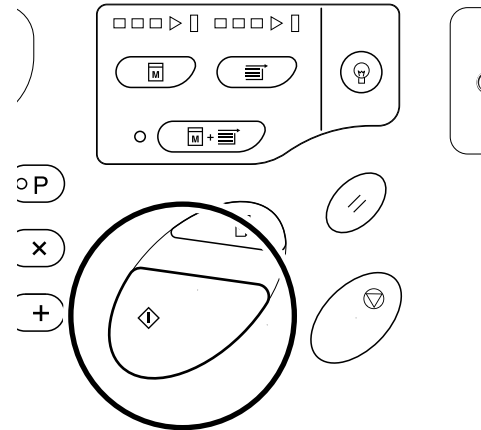

Note:

- When necessary entry is completed, the Print Quantity Display restores the normal status and is available for usual operations.

When the i indicator [*2] is off and Error Type indicator [*4] lights









When an Error Type indicator lights, please refer to the following pages.

Error Type	Error No.	Reference page
	d-04	p.87
	d-17	p.88
	If an Error No. "d-xx" other than above is displayed, please refer to the reference pages.	p.87~p.88
	-	p.70
	-	p.68

Troubleshooting

Troubleshooting Tips

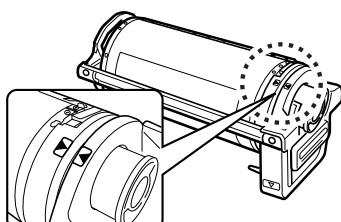
If any problems occur during printing, check the following items and take appropriate procedures before calling your authorized service representative.

Problem	Cause	Action
The machine does not start when the power switch is pressed.	The power was turned off without notice of the Sleep status.	<ul style="list-style-type: none"> Check the indicator on the control panel and turn on the machine. The power switch is turned on when set to , and is turned off when set to .
	Power has been disconnected.	<ul style="list-style-type: none"> Check if the power cord has been firmly connected to a wall socket. Check if the power cord has been firmly connected to the machine. Check if the commercial power circuit breaker is on.
 does not go off even when the Front Cover is closed.	The bottom right of the Front Cover has not been firmly closed.	Firmly close the bottom right of the Front Cover.
The Paper Feed Tray cannot be closed.	<ul style="list-style-type: none"> The Feed Paper Tray Guides have not been widened up to the limit. The power was turned off before the Paper Feed Tray was lowered to the bottom. 	Turn the power on and lower the Paper Feed Tray to the bottom. Set the Feed Tray Paper Guide Lock Lever to  , widen the Feed Tray Paper Guides up to the limit, and close the Paper Feed Tray.
The Print Drum cannot be placed into position.	The Print Drum was stopped at an inappropriate position after rotation.	<p>After manually rotating the drum, make sure that the  mark and the  mark meet as shown.</p> 
	The Print Drum has not been correctly set to the guide.	Set the drum to the guide correctly.  p.75

Problem	Cause	Action
An error indication does not disappear even though consumables (ink, master roll) are set.	The consumables (ink, master roll) have not been correctly set.	After inserting the Ink Cartridge, turn it clockwise (🔒) to lock. Or set the Ink Cartridge again. ☞ p.68 Set a master roll so that the ⓘ mark comes to the left, and set the Master Making Unit. ☞ p.70
	The Ink Cartridge does not contain ink information.	Do not remove the label attached on the Ink Cartridge outlet section. If you did so, set a new Ink Cartridge. ☞ p.68
	The master roll does not contain master information.	Do not remove the ⓘ section from the master core. If you did so, set a new master roll. ☞ p.70
There is no image on copies.	The original is placed face up.	Place the original face down. (This is also true for the ADF unit)
Portion on copies is missing.	A foreign object may exist on the master.	Pull out the Print Drum and check if any object exists on the master. If a foreign object exists between the master and the drum, remove the master. Then set the drum and perform the master-making operation again. ☞ p.83
	<ul style="list-style-type: none"> • The paper size placed on the Paper Feed Tray was not the same as the size of the original at the time of the master-making process. • The Feed Tray Paper Guides were not fit to the width of paper at the time of the master-making process. 	A master is made according to the size of paper placed on the Paper Feed Tray; namely the width of the Feed Tray Paper Guides and the length of paper. If the size of paper placed on the tray is smaller than the size of the original, a master is not made for the entire original. Set the same size of paper on the tray as the original and perform the master-making operation.

Troubleshooting

Problem	Cause	Action
In the Book shadow editing, the position for shadow erasure is shifted.	Custom-size paper has been placed on the Paper Feed Tray.	The Book shadow editing does not allow custom-size paper to be used. Set standard-size paper.
	Custom-size book or magazine was placed as an original.	Place a book or magazine on the Platen Glass so that its binding section comes to the centre of the paper size placed on the Paper Feed Tray (or the size specified for the Size of originals for Book shadow editing using the Custom Setting mode).
	The size of the original differs from the Size of originals for Book shadow editing specified using the Custom Setting mode.	<p>Check the Size of originals for Book shadow editing specified in the Custom Setting mode.</p> <ul style="list-style-type: none"> • With "0" selected Place standard-size paper of the same size of the original onto the Paper Feed Tray. • With "1" through "4" selected Set the Size of originals for Book shadow editing to the same size as the size of the original. <p>☞ p.59</p>
Shadow erase processing in the Book shadow editing does not erase the central shadow.	The width of the erased central shadow is too narrow.	Using the Custom Setting mode, set the Width of central shadow for Book shadow editing again. ☞ p.59
Vertical blank lines are found on printed copies.	The Thermal Print Head has been smudged.	Open the Master Making Unit Cover and clean the Thermal Print Head. ☞ p.79 If this does not solve the problem, contact your authorized service representative.
The unwanted background of an original is picked up on copies.	If newspaper or coloured paper is used as an original, the background is picked up on copies.	Set the scanning level to "Auto" (for RZ2XX, unavailable) or lower the level, and then perform the master-making operation again. ☞ p.37
Dirt is found on printed copies.	The Platen Glass (and/or the ADF Scanner Glass) is not clean.	Clean the Platen Glass (and/or the ADF Scanner Glass). ☞ p.79



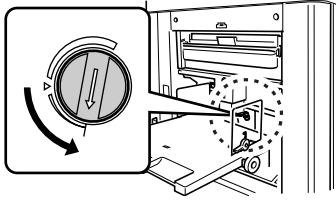
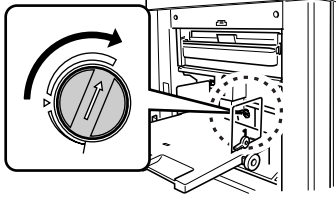

Problem	Cause	Action
The edges of printed copies are smudged with ink.	Larger size of paper than the original was placed on the Paper Feed Tray at the time of the master-making process.	Because a master was made according to a larger size than the original, the edges of the original were processed as shadows. Set the same size of paper as the original and perform the master-making operation again. Or attach tape as described below to solve the problem.
	When printing thick paper such as cards, corners of the paper contacted and damaged the master.	Make another master and print with the new master. Or pull out the Print Drum and attach cellophane tape to the damaged section on the master. However, if attached with cellophane tape, a master may not be properly sent to the Master Disposal Box.
The back of printed copies is smudged with ink.	The Pressure Roller has been stained with ink.	Remove the Print Drum and clean the Pressure Roller. p.80 If the print position is outside the print paper, this may cause the Pressure Roller to be stained with ink. Be careful when changing the size of print paper or shifting the print position.
Printed images are faint. Printed texts are blurred.	If the machine is not used for an extended period of time, ink on the surface of the Print Drum may dry. This results in faint or blurred printing just after printing is started.	Press the  key and make several copies before making copies to be actually used. Or use the Idling function. p.55
	Faint originals result in faint images.	Increase the scanning level and perform the master-making operation again. p.37 For originals written with a pencil, select the Pencil mode. p.33
	If the temperature is low (below 15°C) in a place where the machine is installed or Ink Cartridges are stored, ink does not flow smoothly.	Use the machine after keeping it at room temperature for a while. p.12
	The Ink Saving mode has been set.	With the Ink Saving mode selected, the ink on printed copies is fainter than usual.
The left and right print positions have been shifted.	The left and right print positions have not been adjusted for the centre.	The Paper Feed Tray is equipped with the Horizontal Print Position Adjustment Dial. Lower the tray, adjust the position, and then perform proof copy to check the position. p.46

Troubleshooting

Problem	Cause	Action
Paper sticks to the surface of the Print Drum. (The δ A indicator blinks frequently.)	The margin at the top of the original or print is too small.	The margin of the original (top of the print in the paper output direction) must be 5 mm at least. Lower the vertical print position. If this adjustment is impossible, reproduce an original with enough margin and perform the master-making operation again.
	The print paper is inappropriate.	Use the recommended paper.
	The original has a solid black portion at its top.	If an original has a solid black portion at the top, printed copies may not properly output. Replace the original in the reverse direction and restart the master-making process.
Printed and curled copies are output.	The print paper is loaded at a horizontal grain direction.	Load print paper with a vertical grain direction.
Printed copies are not neatly aligned in the Paper Receiving Tray. (The δ A indicator blinks frequently.)	The positions of the Receiving Tray Paper Guides and the Paper Stopper are inappropriate.	Adjust the Receiving Tray Paper Guides and the Paper Stopper to the size of paper. For thick paper, slightly widen them as necessary. If you have adjusted the horizontal position on the Paper Feed Tray, shift the Receiving Tray Paper Guides in the same direction. p.21
	The positions of the Paper Ejection Wings are inappropriate. (For RZ2XX, unavailable)	Position the Paper Ejection Wings according to the size and thickness of paper. p.21
	The Paper Arrangers are not properly set. (For RZ2XX, unavailable)	Set the Paper Arrangers properly. p.21
	The corrugators are not properly set. (For RZ3XX, unavailable)	Set the corrugators properly. p.21

Problem	Cause	Action
Paper is not smoothly fed from the Paper Feed Tray. (No paper is fed.)	The position of the Paper Feed Pressure Adjustment Lever was inappropriate.	For thick or smooth-surface paper, set the Paper Feed Pressure Adjustment Lever to "X". p.19
	The angle of the Stripper Plate is inappropriate.	If the above adjustment does not solve the problem, use the following procedure: Turn the Stripper Plate Angle Adjustment Dial in the arrow direction to adjust the angle of the Stripper Plate.  <p>Important!:</p> <ul style="list-style-type: none"> • Before performing the adjustment, always remove paper from the Paper Feed Tray and check that the tray has been lowered to the bottom.
Paper is not smoothly fed from the Paper Feed Tray. (Piled paper is feed)	The angle of the Stripper Plate is inappropriate.	Turn the Stripper Plate Angle Adjustment Dial in the arrow direction to adjust the angle of the Stripper Plate.  <p>Important!:</p> <ul style="list-style-type: none"> • Before performing the adjustment, always remove paper from the Paper Feed Tray and check that the tray has been lowered to the bottom.
Paper frequently jams in the paper feed section even when the Paper Feed Pressure Adjustment Lever is set to "X".	The angle of the Stripper Plate is inappropriate.	Refer to the procedure provided for "Paper is not smoothly fed from the Paper Feed Tray. (No paper is fed.)", and adjust the angle of the Stripper Plate.
The back of printed cards is peeling or the leading edge of the printed cards is wrinkled.	The angle of the Stripper Plate is inappropriate.	Refer to the procedure provided for "Paper is not smoothly fed from the Paper Feed Tray. (No paper is fed.)", and adjust the angle of the Stripper Plate.

Troubleshooting

Problem	Cause	Action
The  indicator lights even when a paper jam has not occurred.	Lifted paper was ejected at the time of the second rotation of the Print Drum.	Check the printed copies, and if the top margin is less than 5 mm, slightly lower the print position.
	Because sunlight was projected to the machine, the sensor did not function correctly.	Use a curtain for example to shut out sunlight or move the machine to a place free from direct sunlight.
The machine repeats the master-making process for each original.	“Collate Copies” or “Collate” was selected for printer driver settings for the received document data.	Cancel the current print job and resend the document data without “Collate Copies” or “Collate” selected for the printer driver settings.
The  key blinks.	Received data is waiting for output.	Press the  key to output the data. To delete data waiting for output, press the  key.
“ - - - - ” appears on the Print Quantity Display and the machine does not start.	When the machine is in use, the power was turned off.	Press the  key.



Troubleshooting

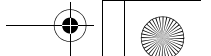

Appendixes

Optional Accessories

A variety of optional accessories are available to enhance the capabilities of the machine. For details about the optional accessories, see their respective user's manuals.

- **Colour Drum**
A variety of colours are available, such as blue, red, green, and brown. Store a drum in its own case.
- **Auto Document Feeder AF-V**
Feeds up to 50 sheets of originals automatically.
- **Job Separator IV:N**
With the Programmed Printing function, allows the machine to print and sort into groups separated by tape.
- **Key Card Counter IV:N**
With a single button press, shows the numbers of printed copies and consumed masters within a given period of time. This can help you manage costs.
- **Special Paper Feed Kit**
Use for thick paper such as cards and envelopes. Replace with this unit when thick paper needs to pass through the machine.
- **Stand**

- **Printer Control Board RISORINC3N**
Use to connect a computer to the machine using a parallel cable.
- **RISO PRINTER Network Interface Card RISORINC-NET**
Use to directly connect the machine to the network.
This comes with the RISO-MONITOR software that allows you to check the status of the machine from computers.

Specifications

RISO RZ370

Master-making/printing methods	High-speed digital master-making/full automatic stencil printing
Original Type	Book (10 kg or less), sheet
Original Size (max./min.)	When using the Platen Glass : 50mm × 90mm - 297mm × 432mm When using the ADF unit (option) : 90mm × 140mm - 297mm × 432mm
Original Paper Weight	When using the Platen Glass : 10 kg or less When using the ADF unit (option) : 50g/m ² - 110g/m ²
Print Paper Size (max./min.)	100mm × 148mm - 297mm × 432mm
Paper Supply Capacity	1000 sheets (64 g/m ²)
Print Paper Weight	46g/m ² - 210g/m ²
Image Processing Mode	Line, Photo, Duo, Pencil
Resolution	Digital 600dpi
Master-making Time	Approx. 16 seconds (for A4/landscape/100% reproduction ratio)
Printing Area (max.)	291mm × 413mm
Print Reproduction Ratio	Zoom : 50 - 200% Standard reproduction ratio (enlargement) : 141%, 122%, 116% Standard reproduction ratio (reduction) : 94%, 87%, 82%, 71%
Print Speed	Approx. 60 - 130 sheets per minute (five steps variable)
Print Position Adjustment	Vertical : ±15mm Horizontal : ±10mm
Ink Supply	Full automatic (1000 ml per cartridge)
Master Supply/Disposal	Full automatic (approx. 220 sheets per roll)
Master Disposal Capacity	100 sheets
User Interface	LED panel with Progress Arrow indicators, front-side operation
Optional Accessories	Auto Document Feeder AF-V, Job Separator IV:N, Key Card Counter IV:N, Colour Drum, Network Interface Card RISORINC-NET, Special Paper Feed Kit, Stand, Printer Control Board RISORINC3N
Power Source	RZ370EP : 220V-240V AC, 50/60Hz <1.3A>
Dimensions	When in use : 1380mm(W) × 645mm(D) × 660mm(H) When in storage : 775mm(W) × 645mm(D) × 660mm(H)
Weight	Approx. 100 kg

Note:

- The specifications are subject to change without prior notice.

Appendixes

RISO RZ300

Master-making/printing methods	High-speed digital master-making/full automatic stencil printing
Original Type	Book (10 kg or less), sheet
Original Size (max./min.)	When using the Platen Glass : 50mm × 90mm - 297mm × 432mm When using the ADF unit (option) : 90mm × 140mm - 297mm × 432mm
Original Paper Weight	When using the Platen Glass : 10 kg or less When using the ADF unit (option) : 50g/m ² - 110g/m ²
Print Paper Size (max./min.)	100mm × 148mm - 297mm × 432mm
Paper Supply Capacity	1000 sheets (64g/m ²)
Print Paper Weight	46g/m ² - 210g/m ²
Image Processing Mode	Line, Photo, Duo, Pencil
Resolution	Digital 600dpi
Master-making Time	Approx. 22 seconds (for A4/portrait/100% reproduction ratio)
Printing Area (max.)	210mm × 290mm
Print Reproduction Ratio	Zoom : 50 - 200% Standard reproduction ratio (enlargement) : 141%, 122%, 116% Standard reproduction ratio (reduction) : 94%, 87%, 82%, 71%
Print Speed	Approx. 60 - 130 sheets per minute (five steps variable)
Print Position Adjustment	Vertical : ±15mm Horizontal : ±10mm
Ink Supply	Full automatic (1000 ml per cartridge)
Master Supply/Disposal	Full automatic (approx. 295 sheets per roll)
Master Disposal Capacity	100 sheets
User Interface	LED panel with Progress Arrow indicators, front-side operation
Optional Accessories	Auto Document Feeder AF-V, Job Separator IV:N, Key Card Counter IV:N, Colour Drum, Network Interface Card RISORINC-NET, Special Paper Feed Kit, Stand, Printer Control Board RISORINC3N
Power Source	RZ300EP : 220V-240V AC, 50/60Hz <1.3A>
Dimensions	When in use : 1380mm(W) × 645mm(D) × 660mm(H) When in storage : 775mm(W) × 645mm(D) × 660mm(H)
Weight	Approx. 100 kg

Note:

- The specifications are subject to change without prior notice.

RISO RZ230

Master-making/printing methods	High-speed digital master-making/full automatic stencil printing
Original Type	Book (10 kg or less), sheet
Original Size (max./min.)	When using the Platen Glass : 50mm × 90mm - 257mm × 364mm When using the ADF unit (option) : 90mm × 140mm - 257mm × 364mm
Original Paper Weight	When using the Platen Glass : 10kg or less When using the ADF unit (option) : 50g/m ² - 110g/m ²
Print Paper Size (max./min.)	100mm × 148mm - 297mm × 432mm
Paper Supply Capacity	1000 sheets (64g/m ²)
Print Paper Weight	46g/m ² - 157g/m ²
Image Processing Mode	Line, Photo, Duo
Resolution	300dpi
Master-making Time	Approx. 25 seconds (for A4/portrait/100% reproduction ratio)
Printing Area (max.)	251mm × 357mm
Print Reproduction Ratio	Standard reproduction ratio (enlargement) : 141%, 122%, 116% Standard reproduction ratio (reduction) : 94%, 87%, 82%, 71%
Print Speed	Approx. 60 - 130 sheets per minute (five steps variable)
Print Position Adjustment	Vertical : ±15mm Horizontal : ±10mm
Ink Supply	Full automatic (1000 ml per cartridge)
Master Supply/Disposal	Full automatic (approx. 250 sheets per roll)
Master Disposal Capacity	100 sheets
User Interface	LED panel with Progress Arrow indicators, front-side operation
Optional Accessories	Auto Document Feeder AF-V, Job Separator IV:N, Key Card Counter IV:N, Colour Drum, Network Interface Card RISORINC-NET, Special Paper Feed Kit, Stand, Printer Control Board RISORINC3N
Power Source	RZ230EP : 220V-240V AC, 50/60Hz <1.3A>
Dimensions	When in use : 1380mm(W) × 645mm(D) × 660mm(H) When in storage : 775mm(W) × 645mm(D) × 660mm(H)
Weight	Approx. 95kg

Note:

- The specifications are subject to change without prior notice.

Appendixes

RISO RZ200

Master-making/printing methods	High-speed digital master-making/full automatic stencil printing
Original Type	Book (10 kg or less), sheet
Original Size (max./min.)	When using the Platen Glass : 50mm × 90mm - 257mm × 364mm When using the ADF unit (option) : 90mm × 140mm - 257mm × 364mm
Original Paper Weight	When using the Platen Glass : 10kg or less When using the ADF unit (option) : 50g/m ² - 110g/m ²
Print Paper Size (max./min.)	100mm × 148mm - 297mm × 432mm
Paper Supply Capacity	1000 sheets (64g/m ²)
Print Paper Weight	46g/m ² - 157g/m ²
Image Processing Mode	Line, Photo, Duo
Resolution	300dpi
Master-making Time	Approx. 25 seconds (for A4/portrait/100% reproduction ratio)
Printing Area (max.)	210mm × 290mm
Print Reproduction Ratio	Standard reproduction ratio (enlargement) : 141%, 122%, 116% Standard reproduction ratio (reduction) : 94%, 87%, 82%, 71%
Print Speed	Approx. 60 - 130 sheets per minute (five steps variable)
Print Position Adjustment	Vertical : ±15mm Horizontal : ±10mm
Ink Supply	Full automatic (1000 ml per cartridge)
Master Supply/Disposal	Full automatic (approx. 295 sheets per roll)
Master Disposal Capacity	100 sheets
User Interface	LED panel with Progress Arrow indicators, front-side operation
Optional Accessories	Auto Document Feeder AF-V, Job Separator IV:N, Key Card Counter IV:N, Colour Drum, Network Interface Card RISORINC-NET, Special Paper Feed Kit, Stand, Printer Control Board RISORINC3N
Power Source	RZ200EP : 220V-240V AC, 50/60Hz <1.3A>
Dimensions	When in use : 1380mm(W) × 645mm(D) × 660mm(H) When in storage : 775mm(W) × 645mm(D) × 660mm(H)
Weight	Approx. 95kg

Note:

- The specifications are subject to change without prior notice.

Feature List

Feature	RZ370/RZ300	RZ230/RZ200
Standard Reproduction Ratio	○	○
Zoom	○	NA
Dot process	○	NA
Scanning level (five manually variable steps)	○	○
Scanning level (auto)	○	NA
Book shadow edit	○	○
Programmed Printing	○	○
2-Up printing	○	○
Ink Saving	○	○
Pencil	○	NA
Custom Setting mode	○	○
Confidential mode	○	○
Auto idling	○	NA
Idling (manual)	○	○
Energy Saving mode	○	○
Auto-Process	○	○
Print speed	○	○
Print density	○	NA
Paper Ejection Wing Adjustment	○	NA
Paper Arranger	○	NA
Corrugator	NA	○
Link Print	Optional	NA

Index

Symbols

* Key	8
+ Key	9
× Key	9

Numerics

1:1 Key	10, 35
2-Up Indicator	10, 41
2-Up Key	10, 41
2-Up Printing	39
2-Up Printing Interval Time	59

A

ADF Original Guide	7
ADF Original Receiving Tray	7
ADF Original Release Button	7
ADF Original Release Dial	7
ADF Original Stopper	7
ADF Scanner Glass	7
Appendixes	100
Auto Clear Time	60
Auto Document Feeder AF-IV	100
Auto Idling	55
Auto Idling Time	59
Auto Scanning Level Adjustment Indicator	10
Auto Scanning Level Adjustment Key	10
Auto-Process	43
Auto-Process Indicator	8, 43
Auto-Process Key	8, 43

B

Basic Operational Flow	26
Basic Operations	24, 27
Beep Sound	61
Book Key	10, 38
Book Key Indicator	10, 38
Book Shadow Edit	38
Book Shadow Editing	59
Book Shadow Editing Centre Width	59

C

C Key	8
Call Service Indicator	82, 89
Centre Erasure	38
Check Error Display	82
Check Error Display Indication	8, 82
Check Settings Indicator	82, 87
Cleaning	78
Cleaning Safety Guide	78
Colour Drum	100
Computer Connection	14
Computer-generated Data Printing	30
Confidential Indicator	11, 56
Confidential Key	11, 56
Confidential Mode	56
Consumable Replacement and Discard	68

Consumables	25
Control Panel	8
Corrugator	23
Counter	7
Custom	11, 63, 65, 67
Custom Indicator	11, 63, 65, 67
Custom Setting Mode	59

D

Depleted Consumable Discard	74
Display	7
Dot Process	34
Dot Screen Key	10, 34
Dot Screening	34
Dot Screening Indicator	10, 34
Duo Mode	32

E

Empty Disposal Box Indicator	82, 89
Energy Saving Mode	60
Energy Saving Mode Wait time	60
Enlargement	35
Error Location Indicator	82
Error Number Display	8, 82
Error Type Indicator	82

F

Feature List	105
Feed Tray Descent Button	7, 20
Feed Tray Paper Guide	7, 19
Feed Tray Paper Guide Lock Lever	7, 19
Flange	71
Free Reproduction Size Display	10
Free Reproduction Size Ratio	35, 40
Front Cover	7

G

Group	52
Grouping	52

H

H Number Display	90
Horizontal Print Position	48
Horizontal Print Position Adjustment Dial	7, 48

I

i fit indicator	8, 82, 90
Idling	55
Idling Indicator	11, 55
Idling Key	11, 55
Image Processing Mode	32
Image Processing Selection Indicator	10
Image Processing Selection Key	10
Initial Setting Restoration	62
Initial Settings	59
Ink Cap Holder	7, 69
Ink Cartridge	7, 68

Ink Cartridge Replacement	68	Paper Arranger	21
Ink Handling	25	Paper Arranger Knob	7, 21
Ink Saving	44	Paper Document and Book Printing	27
Ink Saving Indicator	10, 44	Paper Ejection Wing	22
Ink Saving Key	10, 44	Paper Ejection Wing Adjustment Dial	7, 22
Installation	12	Paper Feed Pressure Adjustment Lever	7, 19
Interface Indicator	11, 30, 58	Paper Feed Tray	7, 19
Interface Key	11, 30, 58	Paper Feed Tray Setting	19
Introduction to Machine	6	Paper Finish	60
IP Address	62, 65	Paper Jam Indicator	83
J		Paper Receiving Tray	7, 21
Jam Indicator	82	Paper Receiving Tray Setting	21
Job Separation	61	Paper Separation Hook	80
Job Separator IV	100	Paper Stopper	7, 21
K		Parts and Components	6
Key Card Counter V	100	Pencil	33
L		Pencil Mode Indicator	10, 33
Line Mode	32	Pencil Mode Key	10, 33
Linked Printer Tray Paper Size	61	Photo Mode	32
M		Platen Cover	7
Machine Handling	24	Platen Glass	7, 79
Main Control Panel	8	Power Connection	13
Maintenance	79	Power Switch	7, 27
Maintenance Call Indicator	82, 89	Preparation before Printing	19
Master Disposal Box	73	Preparation before use	12
Master Disposal Box Handle	73	Pressure Roller	80
Master Disposal Box Handling	73	Print Density Adjustment	47
Master Guide Flap	7, 71	Print Density Adjustment Indicator	8
Master Replacement	70	Print Density Adjustment Key	8, 47
Master Roll	7, 70	Print Drum	7, 75
Master Roll Holder	7, 70	Print Drum Handle	7, 75
Master-Making Key	8	Print Drum Pullout and Installation	75
Master-Making Unit	7, 70	Print Drum Release Button	7, 75
Master-Making Unit Cover	7, 70	Print Key	8
Master-Making Unit Cover Lever	70	Print Paper	15
Master-Making Unit Handle	7	Print Paper Handling	16
Master-Making Unit Release Button	7, 70	Print Paper Setting	19
Minimum Print Quantity	60	Print Paper Size and Weight Restrictions	15
N		Print Paper Storage Environment	16
Number of sets	52, 53	Print Position Adjustment	48
O		Print Position Adjustment Indicator	8
Operation Environment	24	Print Position Adjustment Key	8, 48
Operation Safety Guide	24	Print Position Centre Key	8, 48
Option	100	Print Quantity	52
Original	17	Print Quantity Display	8
Original Margin	18	Print Quantity Key	8
Original Pad	79	Print Speed Adjustment	50
Original Restrictions	18	Print Speed Adjustment Indicator	8
Original Size and Weight Restrictions	17	Print Speed Adjustment Key	8, 50
P		Printer Control Board RISORINC 3N	100
P Indicator	8, 53	Printer Control Board RISORINC3N	14
P Key	8, 53	Printer Exterior	80
		Programmed Printing	52
		Progress Arrow	8
		Proof	46
		Proof Key	9, 46
		Push-out Lever	73

Index

R

Receiving Tray Paper Guide	7, 21
Reduction	35
Replace Ink Cartridge Indicator	82, 89
Replace Master Roll Indicator	70, 82, 89
Reproduction Size Selection Key	10, 35, 36
Reservation Period	30, 61
Reset Key	9
RISORINC-NET	14, 100

S

Safety Guide	12
Scanner Glass	81
Scanning Level Adjustment	37
Scanning Level Adjustment Key	10
Semi-Auto(ADF unit)	61
Special Paper Feed Kit	100
Specifications	101
Stand	100
Standard	35
Start Key	9
Stop Key	9
Stripper Plate Angle Adjustment Dial	97
Sub Control Panel	10

T

Troubleshooting	82
Troubleshooting Tips	92
Two-original (side-by-side) Printing	39

V

Vertical Position	48
-------------------------	----

W

Wake-up Key	8
White Sheet	81

Z

Zoom Key	10, 36
Zoom Ratio	36